City of Lowell

Lane County, Oregon



STORMWATER MASTER PLAN

October 2008

Project No. 2101-002

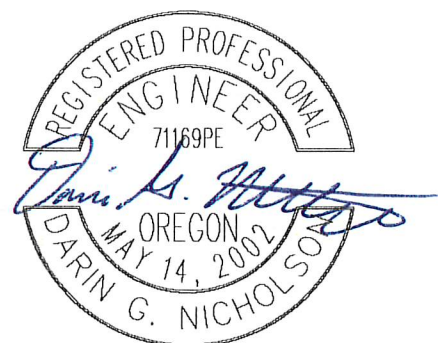

RENEWAL DATE: 12/31/08

Civil West
Engineering Services, Inc.



486 E Street, Suite 8
Coos Bay, Oregon 97420
Phone: 541/266-8601
Fax: 541/266-8601

Table of Contents

1.0	Executive Summary	1-1
1.1	Introduction.....	1-1
1.2	Existing System	1-1
1.3	Identification of Deficiencies and Development of Improvement Alternatives	1-2
1.4	Recommended Plan	1-2
	Table 1-1 – Storm Drain System Project Prioritization Summary	1-3
1.5	Plan Implementation	1-3
1.6	Potential Financing Options.....	1-4
1.7	Potential Impacts to Rate Payers.....	1-4
2.0	Introduction, Purpose and Need	2-1
2.1	Background.....	2-1
2.2	Previous Planning Efforts	2-1
2.3	Purpose and Need	2-1
2.4	Scope of Engineering Services	2-2
2.5	Authorization	2-3
2.6	Acknowledgements.....	2-3
3.0	Study Area Characteristics	3-1
3.1	Study Area	3-1
3.2	Physical Environment	3-1
3.2.1	Climate	3-1
	Figure 3-1 –Monthly Mean Precipitation.....	3-2
	Figure 3-2 – Average Annual Precipitation.....	3-2
	Figure 3-3 – Regional Location Map	3-3
	Figure 3-4 –Study Area Map.....	3-4
3.2.2	Soils and Geology.....	3-5
3.2.3	Geologic Hazards	3-5
	Figure 3-5 – Soils Map.....	3-6
3.2.4	Water Resources.....	3-7
3.2.5	Flora and Fauna	3-7
3.3	Socio-Economic Environment.....	3-8
3.3.1	Economic Conditions and Trends	3-8
3.3.2	Population.....	3-8
	Table 3-1 – County and City Historical Population	3-8
	Table 3-2 – County and City Historical Estimates.....	3-9
	Table 3-3 – Population Projections	3-9
3.4	Land Use.....	3-10
	Table 3-4 – Land Use Summary.....	3-10
	Figure 3-6 – Land Use Designation Map	3-11
3.4.1	Drainage Basins.....	3-12
	Table 3-5 – Drainage Basin Characteristics	3-12
3.4.2	Equivalent Dwelling Unit (EDU) Methodology	3-12
	Table 3-6 – Existing EDU’s per Drainage Basin	3-13
3.4.3	Future EDU’s	3-13
	Table 3-7 – Basins’ Percentage of Projected New EDUs	3-14
	Table 3-8 – Future EDU’s per Drainage Basin	3-14
4.0	Existing Stormwater Facilities	4-1
4.1	General.....	4-1
4.2	Information Gathering and Sources	4-1

4.3	Storm Drainage System Overview.....	4-1
	Figure 4-1 Existing Drainage Basins.....	4-2
4.3.1	Basin A.....	4-3
4.3.2	Basin B.....	4-3
4.3.3	Basin C.....	4-4
4.3.4	Basin D.....	4-5
4.3.5	Basin E.....	4-6
4.3.6	Basin F.....	4-7
4.3.7	Basin G.....	4-8
4.4	Existing Storm Drain System Inventory.....	4-9
	Table 4-1 – Storm Drain Manhole and Catch Basin Inventory.....	4-10
	Table 4-2 – Storm Drain Pipe Inventory.....	4-10
4.4.1	Storm Drain Outfalls.....	4-10
	Table 4-3 – Storm Drain Outfall Summary.....	4-13
4.4.2	Culverts.....	4-13
	Table 4-4 – Culvert Summary.....	4-22
5.0	Hydrologic Analysis.....	5-1
5.1	Rational Method.....	5-1
5.2	SCS Rainfall Runoff Relationship.....	5-2
5.2.1	Factors Affecting Runoff Volume.....	5-2
5.2.2	SCS Rainfall-Runoff Equation.....	5-2
5.2.3	Runoff Curve Numbers.....	5-3
	Table 5-1 - SCS Curve Numbers for Identified Land Uses.....	5-4
5.2.4	Time of Concentration.....	5-4
	Table 5-2 - Land Cover Coefficients.....	5-5
	Table 5-3 - Manning's <i>n</i> for Partially Full Pipes and Open Channels.....	5-6
5.2.5	Rainfall.....	5-6
	Figure 5-1 - Geographic Areas for SCS Rainfall Distributions.....	5-7
	Figure 5-2 – SCS 24-Hour Rainfall Distributions.....	5-8
	Table 5-4 – Design Storm Rainfall Totals for Lowell.....	5-9
5.2.6	Hydrograph and Discharge.....	5-9
6.0	Storm Drain Model.....	6-1
	Table 6-1 – SCS Curve Numbers for Identified Land Uses.....	6-1
6.1	Basin Descriptions.....	6-1
6.1.1	Basin A.....	6-2
	Figure 6-1 – Basin A.....	6-4
6.1.2	Basin B.....	6-5
	Figure 6-2 – Basin B.....	6-6
6.1.3	Basin C.....	6-7
	Figure 6-3 – Basin C.....	6-9
6.1.4	Basin D.....	6-10
	Figure 6-4 – Basin D.....	6-14
6.1.5	Basin E.....	6-15
	Figure 6-5 – Basin E.....	6-17
6.1.6	Basin F.....	6-18
	Figure 6-6 – Basin F.....	6-20
6.1.7	Basin G.....	6-21
	Figure 6-7 – Basin G.....	6-24
	Figure 6-14 – Proposed Basin G.....	6-29
7.0	Basis of Planning.....	7-1
7.1	Design Criteria.....	7-1

7.1.1	Design Period	7-1
7.1.2	Storm Drain & Culvert Design.....	7-1
	Figure 7-1 – Storm Drain Pipe Elevation Details.....	7-2
	Table 7-1 – Recommended Slopes for Storm Drains (ft/ft)	7-3
7.1.3	Storm Drain Pipe Materials	7-3
7.2	Basis for Cost Estimate.....	7-4
7.2.1	Construction Costs.....	7-4
	Table 7-2 – Index 1990 to 2008	7-5
7.2.2	Contingencies	7-5
7.2.3	Engineering	7-5
7.2.4	Legal and Administrative	7-6
7.2.5	Land Acquisition Costs	7-6
7.2.6	Other Studies and Special Investigations	7-7
7.3	Regulatory Criteria.....	7-7
7.4	Water Quality Issues	7-8
	Table 7-3 – Median Runoff Concentration by Land Use Category	7-9
7.5	TMDL Implementation	7-9
8.0	Development and Evaluation of Projects	8-1
8.1	Storm Drain System Piping Projects.....	8-1
8.1.1	Basin A.....	8-1
	Table 8.1.1 – Storm Drain System Project A1	8-1
	Table 8.1.2 – Storm Drain System Project A2	8-2
8.1.2	Basin B.....	8-2
8.1.3	Basin C	8-2
	Table 8.1.3 – Storm Drain System Project C1	8-2
	Table 8.1.4 – Storm Drain System Project C2	8-3
8.1.4	Basin D.....	8-4
	Table 8.1.5 – Storm Drain System Project D1	8-4
	Table 8.1.6 – Storm Drain System Project D2	8-4
	Table 8.1.7 – Storm Drain System Project D3	8-5
	Table 8.1.8 – Storm Drain System Project D4	8-5
8.1.5	Basin E	8-6
	Table 8.1.9 – Storm Drain System Project E1	8-6
8.1.6	Basin F.....	8-6
8.1.7	Basin G.....	8-7
	Table 8.1.10 – Storm Drain System Project G1	8-7
	Table 8.1.11 – Storm Drain System Project G2	8-7
	Table 8.1.12 – Storm Drain System Project G3	8-8
8.1.8	Western Drainage	8-8
	Table 8.1.13 – Western Drainage Improvements	8-8
8.1.9	TMDL Implementation	8-9
	Table 8.1.14 – Storm Drain System Project TMDL	8-9
8.2	Cleaning and Televising	8-9
8.3	Storm Drain System Management and Maintenance.....	8-9
8.3.1	Preventative Maintenance.....	8-9
8.3.2	Routine Maintenance.....	8-10
	Table 8.1.15 – Maintenance Schedule	8-10
8.4	Documentation and Recordkeeping	8-10
9.0	Recommended Plan.....	9-1
9.1	Introduction.....	9-1
9.2	Project Cost Summary	9-2

Table 9-1 – Storm Drain System Improvement Project Summary.....	9-2
9.3 Project Prioritization.....	9-3
Table 9-2 – Storm Drain System Project Prioritization Summary.....	9-3
9.4 Implementation Plan.....	9-4
9.4.1 Schedule.....	9-4
9.4.2 Potential Financing Options.....	9-5
9.4.3 Potential Impacts to Rate Payers.....	9-6
Table 9-3 – Project Prioritization Summary.....	9-6
Appendix A Runoff Calculations.....	A-1
Appendix B Runoff Curve Numbers (Table 2-2, TR-55).....	1
Appendix C Isopluvial Maps, 24-Hour Precipitation.....	1

Stormwater Master Plan

Chapter 1

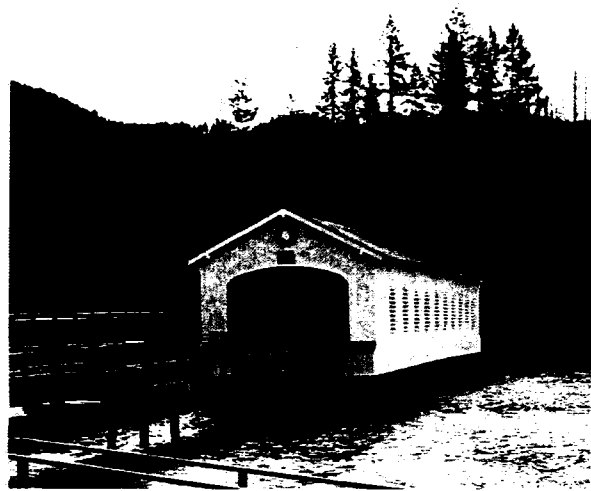

1.3 Identification of Deficiencies and Development of Improvement Alternatives

All of the existing storm drainage system components were analyzed for deficiencies that exist presently. Facilities also have been evaluated for deficiencies that are expected to occur within the 20-year planning period and under buildout conditions. Deficiencies were identified related to the age and condition of facilities, anticipated development, and capacity.

As part of this planning effort, calculations were made to estimate the peak stormwater flows that could be expected from each basin under existing and future development conditions. Runoff calculations for the various storm drainage basins identified in this Master Plan were performed using a method developed by the Soil Conservation Service (SCS; now NRCS) for relating rainfall to runoff. The method is described in length in Technical Release 20 (TR-20) published by the SCS. The TR-20 method is based upon unit hydrograph theory and the runoff curve number method of calculating direct runoff from the rainfall occurring over specified areas. It considers an entire watershed with a variety of land uses and soil types. The TR-20 method also allows watershed areas (basins) to be divided into subbasins for analysis purposes, with drainage routes of one or more subbasins running through other subbasins downstream. This provides for the calculation of an overall peak discharge from a basin that may or may not equal the sum of the peak discharges from the individual subbasins.

Stormwater runoff calculations are further discussed in Chapter 5 of this Master Plan. Results of runoff calculations are presented in Appendix A.

1.4 Recommended Plan

In the final chapter of this Master Plan, a number of projects are identified which will address various deficiencies within the storm drainage system. Individual projects are grouped into three priority classifications. Each classification group is loosely defined as follows:

Group A: These are the highest priority projects that should be undertaken as soon as adequate funding is available. It should be considered that these projects should be undertaken within the next 5 years with highest projects on the list to be addressed in the next year or two.

Group B: These projects, while not of the highest priority, should be on the City's capital improvement planning window beyond the 5-year horizon. As Group A projects are completed, Group B projects should be moved to Group A status. System degradation or failures, project coordination, or other occurrence may require the movement of Group B projects to Group A status ahead of schedule. New projects that are developed that are not critical, should be grouped in Group B until funding is available.

Group C: Group C projects are either of low priority or are dependent on development. If development in an area necessitates the implementation of a Group C improvement, the project should be moved to Group A status assuming that adequate funding is available to undertake it. Some projects may remain in Group C indefinitely if the need for the project or the development requiring it never arises.

Table 1-1 below summarizes the projects that have been developed for the City of Lowell storm drain system. A total of 14 projects have been developed totaling \$763,702.00 in improvements and an

additional \$10,000 for the TMDL Implementation Plan. High priority projects (Group A) for the storm drain system total \$443,594.00 in planned improvements.

Table 1-1: Storm Drain System Project Prioritization Summary

	Priority Rating	Project Number	Project Name (Description)	Total Project Cost
A	1	TMDL	TMDL Implementation Plan	\$10,000.00
	2	G1	Everly Street Drainage Improvements	\$94,464.00
	3	WD	Western Drainage Easement/Rehab/Relocation	\$185,792.00
	4	E1	Eastern Drainage – Pipe Improvements & Relocation	\$141,936.00
	5	C2	24" Culvert Outlet & Ditch Improvements, Moss Street	\$21,402.00
B	6	D3	3 rd Street Outfall and Swale Enhancement	\$54,612.00
	7	D1	Tree Planting, 4 th Street Swale west of Moss Street	\$8,700.00
	8	D4	Paul Fisher Park Pipe Extension	\$32,472.00
	9	G2	TV Inspection, Loftus Street Storm Drain	\$3,700.00
	10	G3	TV Inspection and Repair, Moss Street Storm Drain	\$16,974.00
	11	D2	TV Inspection, D Street north of 4 th Street	\$700.00
C	12	C1	36" Culvert Replacement, Moss Street at 6 th Street	\$165,312.00
	13	A1	18" Culvert Replacement, Moss Street north of Seneca	\$19,188.00
	14	A2	24" Culvert Replacement, 7 th Street west of Moss Street	\$18,450.00
Total				\$773,702.00

1.5 Plan Implementation

It is presumptuous to develop a strict schedule and order for the implementation of the projects developed in this Master Plan. Funding sources, development pressures, economic environment, and other variables will steer the implementation of the plan.

It is recommended that the City maintain the 3-Group approach discussed above. By working to complete the high priority projects and maintaining a dynamic, working capital improvement plan (CIP), the City will systematically complete the projects necessary to maintain and improve their storm drainage system.

In order to make timely progress in completing the recommended improvements, the City should immediately begin developing a plan to finance the projects selected for completion.

Scenario 3: In this scenario, it is assumed that the City will aggressively pursue the proposed projects by obtaining funding to complete both Priority A and Priority B groups. Under this more aggressive approach, the following impact to ratepayers applies:

Principal: \$570,752.00
Interest Rate: 5% per year
Term: 20-years (240 months)
Monthly Payment: \$3,751.08
EDU's: 498

Based on these terms, the rate needed per EDU required to pay back a loan of the indicated principal amount is approximately \$7.53 per month. However that does not include the approximate \$6,000 annual budget to maintain and inventory the existing system. That increases the monthly amount needed to be collected by \$500.00 to \$4,251.08. Based on the same number of EDU's, that would result in a storm water utility fee of \$8.54 per month.

The City owns and maintains a storm drain system which is constantly degrading. As portions of the system reach the end of their useful life and development pressures increase, the City must raise the necessary funds to maintain and expand the system as required. While establishment of new user fees and rate increases are not easy for any community, the City must weigh their available resources against what is needed to fund the necessary improvements to provide proper drainage in developed areas and protect property against damage.

1.6 Potential Financing Options

Based on the recommendations of this Master Plan, the City soon will be considering undertaking a number of storm drain system improvement projects. The overall cost of these projects will be \$773,702.00 dollars. As discussed in Section 9.4, funding assistance is not typically available for storm drain system improvements since public health is not at stake. Non-grant funding includes bonds, loans, system development charges (SDC's), capital construction funds (sinking funds), local improvement districts, and others.

It is expected that loans and bonds will be available to the City with interest rates on the order of 5 percent depending on the status of the federal prime rates, the term of the loans, the source of revenue used to payback the funds (user rates, general fund taxes, etc.), and other variables.

The City of Lowell does not presently have a specific user fee for storm drain system maintenance that is charged to rate payers. It has been assumed that a portion of the transportation budget is diverted to cover storm drain system projects as necessary. In order to appropriately fund the storm drain system improvement projects identified in this Plan it is recommended that the City modify its rate structure to include a separate storm drain maintenance and improvement category. We understand that modifying the City's service rate structure is a difficult process and requires public approval in order to implement changes.

Appropriate user fees for storm drainage system maintenance and improvements could be determined by several different methods. It is recommended for simplicity that charges be determined on an Equivalent Dwelling Unit (EDU) basis as introduced in Sections 3.4.2 and 3.4.3. Under the described system, each single family dwelling would typically be charged an equal rate for one EDU. Commercial and industrial customers would be charged a rate for a number of EDU's calculated based on the amount of impermeable surface present on the site. In this way, customers having larger areas of impermeable surface, and which generate greater volumes of runoff, would be responsible for a greater portion of system maintenance and improvement fees.

Because the storm drain projects recommended herein will require significant capital for construction and repayment of loans or bonds, it is recommended that the City determine a basic rate structure sufficient to cover all existing maintenance costs prior to considering the improvement projects. Once baseline user fees have been determined, fee increases, to cover the cost of the recommended improvements may be applied.

1.7 Potential Impacts to Rate Payers

The impact to rate payers will depend on the projects that the City undertakes, the schedule that they follow, and the user rate structure that is established. The projects developed in this plan have been prioritized in three groups, as indicated in Table 1.1 and further discussed in Chapter 9. The City may choose to complete only the highest priority projects within the initial phase of planning.

A potential funding scenario (excerpted from Chapter 9) is provided below to demonstrate the impact to rate payers:

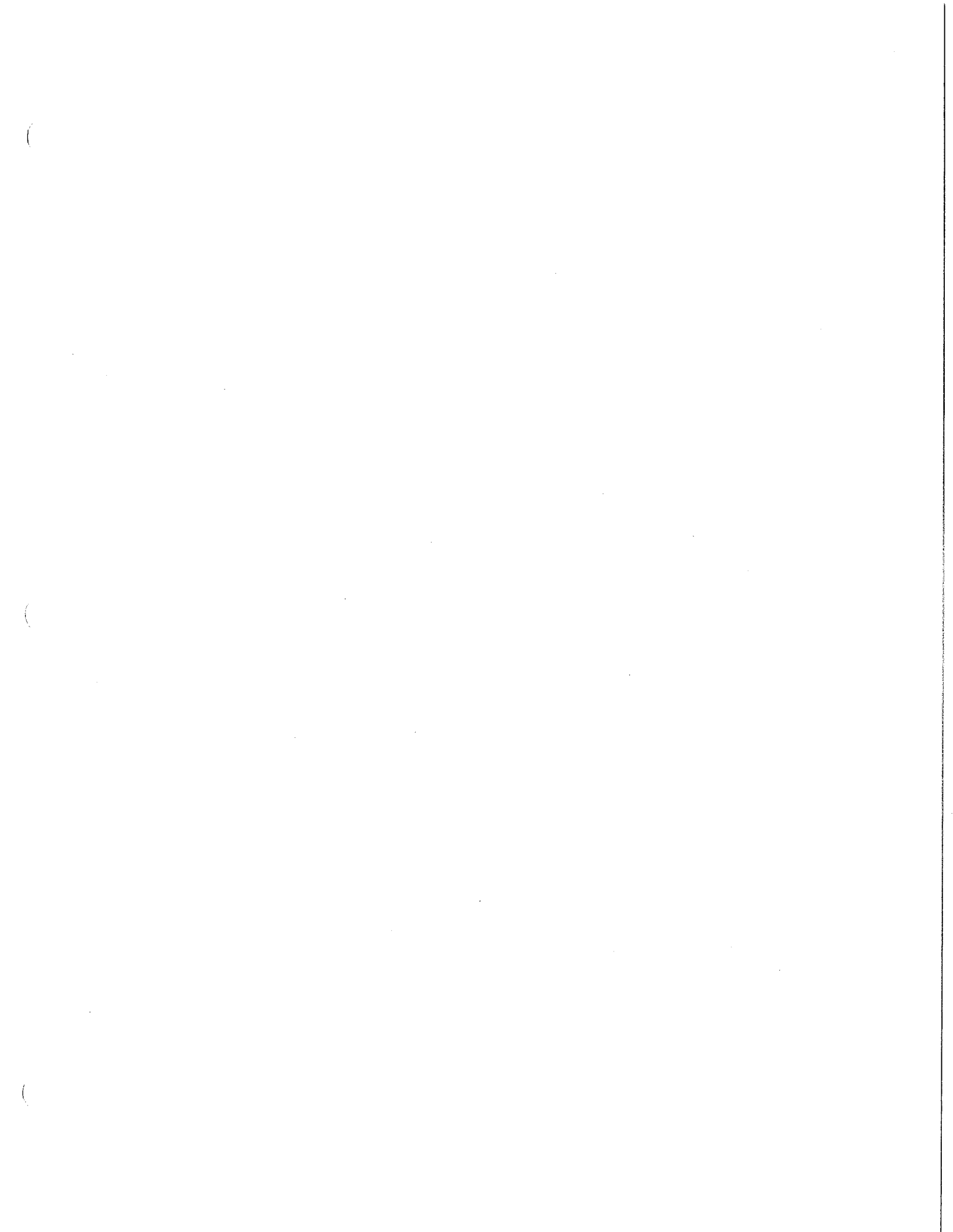

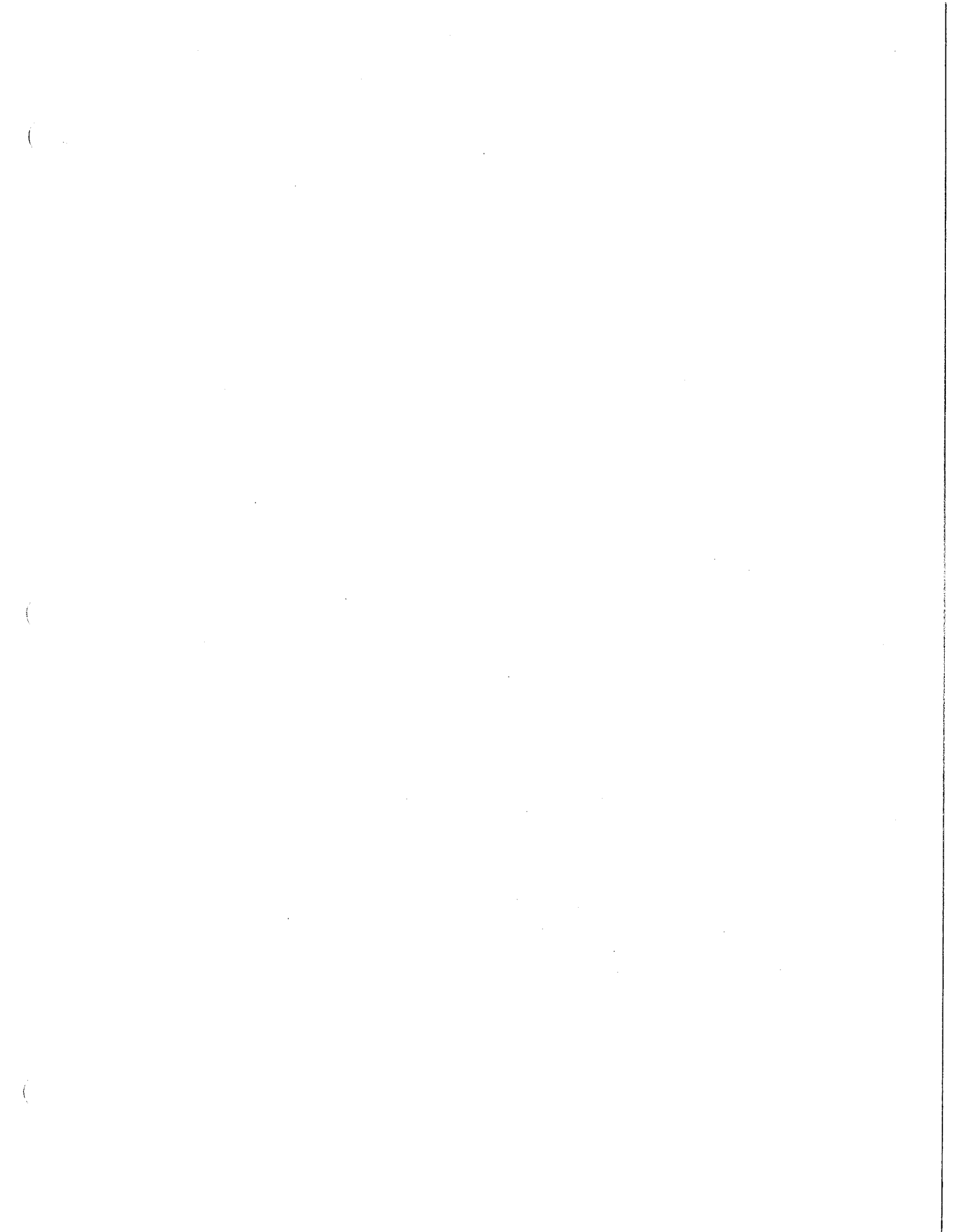

Stormwater Master Plan

Chapter 2



2.0 Introduction, Purpose and Need

2.1 *Background*

The City of Lowell owns and maintains a public stormwater drainage system within the City and Urban Growth Boundary Limits. Much of the City's storm system consists of roadside ditches and culverts that convey water to several seasonal creeks that run through the west, north and east section of the City. The system also includes numerous catch basins, area drains, manholes and approximately two miles of gravity pipe in a range of sizes.

The storm drainage system has been constructed over a number of years as development has occurred. The rate of growth within the City of Lowell has varied over the years. Recently, an increase in the rate of growth has been experienced within the community and City officials expect this new level of growth to continue for some time into the future. As new areas are developed within the City, additional storm drainages systems will be constructed to handle the additional stormwater runoff generated in these areas. However, existing facilities downstream of the new developments may or may not be adequately sized for the increased flows generated by development.

In order to prepare for continued growth and ensure that the City's stormwater drainage system is adequately sized and maintained, the City has chosen to undertake this Stormwater Master Plan.

2.2 *Previous Planning Efforts*

This is the City of Lowell's first Stormwater Master Plan. However, stormwater studies for several private developments within Lowell have been generated and submitted for the City's approval. The city is currently completing a TMDL Implementation Plan which is required by DEQ to reduce pollutants to the Willamette Basin.

2.3 *Purpose and Need*

The overall purpose of this Stormwater Master Plan is to provide the City with the necessary planning information to form the technical, financial, and legal basis required for the establishment of stormwater SDC's, utility fee and design guidelines. This Master Plan will serve as a guide for the management of the storm drain system through the upcoming planning period extending through the year 2028.

Specific objectives of this Master Plan include the following:

- Evaluate the existing storm drain system condition and capacity, and identify current deficiencies.
- Develop potential stormwater system improvements to serve existing and future development within the city limits. These improvements are to include means for the city to reduce their pollutants to the Willamette Basin as prescribed in their TMDL Implementation plan.
- Provide cost estimates and phasing recommendations for the recommended improvements.

2.4 Scope of Engineering Services

The Stormwater Master Plan has been prepared to provide a complete Master Plan for the storm drainage system for the City of Lowell. Tasks that have been completed in the preparation of this Master Plan include the following:

- **Background and Data Gathering** – Available information has been gathered on the existing drainage system in Lowell. Previous planning efforts, as-builts, and field reconnaissance were used in developing the plan.
- **Mapping** – Detailed storm drainage system maps have been developed utilizing the mapping information provided by Lane Council of Governments (LCOG). Drainage basins and watersheds have been overlaid on the maps. Existing storm drain piping has been identified using a color coded sizing system.
- **Modeling** – Existing and future flows have been modeled using the 25-year design storm. Deficient system components and likely flooding areas have been identified and shown on a drainage deficiency map.
- **Alternatives and Recommendations** - Storm drain system piping projects have been developed to address existing capacity deficiencies, maintenance needs, and future development capacity requirements. Alternatives, recommendations, and specific project costs are discussed for each basin
- **Environmental Consideration** – Recommendations, regulatory guidelines, and a schedule have been developed to mitigate the environmental impacts of increasing runoff and comply with Oregon Department of Environmental Quality (DEQ) requirements for Total Maximum Daily Load (TMDL) into Dexter Lake.
- **Capital Improvement Plan** – Under this task, all the data, analysis, and information gathered for the study will be compiled within a final report. The final plan includes a Capital Improvement Plan (CIP) for the City's storm drainage system. The CIP includes an implementation schedule for the proposed improvements as well as financial projections of the anticipated project costs over the planning period. The CIP forms a portion of the basis for the methodology that will be developed for the Storm Drain SDC.
- **Stormwater Administrative Issues** – Recommendations for a new stormwater utility, ordinance, and design standards are included to develop and maintain stormwater facilities and to direct developers, designers, and contractors on what is required with regards to development and drainage in the City of Lowell.
- **Funding Plan** – Under this task, all available and potential funding sources that could be used for storm drainage improvements will be identified. This section will also include background information on stormwater SDC's and outlined the basic information required to establish defensible stormwater SDC in Lowell.

2.5 Authorization

The City of Lowell authorized the firm HBH CONSULTING ENGINEERS, INC. to develop a Stormwater Master Plan by a contract dated December 4, 2007. Services are in accordance with this professional services contract and the HBH proposal for the project which was presented to the City in October 2007. HBH presented a draft of the Master Plan to the City Council in May 2008.

Civil West Engineering Service, Inc. subsequently took on the responsibility to complete the Master Plan and address review comments and concerns raised about the original study. This document constitutes the final revision of the Stormwater Master Plan.

2.6 Acknowledgements

This plan is the result of contributions made by a number of individuals and agencies. In particular, the following persons should be acknowledged for the important roles they played in the preparation, review, and development of this plan:

- Charles SpiesCity of Lowell
- William HartwigCity of Lowell

In addition to these key personnel, we wish to thank the City of Lowell City Council and management staff for providing support and input on the project.

Stormwater Master Plan

Chapter 3



3.0 Study Area Characteristics

3.1 Study Area

Lowell is located in central Lane County Oregon, approximately 20 miles southeast of Eugene, along State Highway 58 (see Figure 3-3, "Regional Location Map"). Lowell is located on Dexter Reservoir in a narrow finger of the southern Willamette Valley formed by the Middle Fork of the Willamette River.

The City Limits and Urban Growth Boundary (UGB) for Lowell are virtually identical at present, with an area of approximately 762 acres (1.19 square miles), which includes 209 acres of Dexter Lake. Thirty-eight percent of the land in Lowell is undeveloped. The City lies in Township 19 South, Range 01 West, W.M. The City of Lowell and its UGB are depicted in Figure 3-4, "Service Area Map". This study is limited in scope to this service area.

Contour information on the USGS Topographic Quadrangle for Lowell, Oregon indicates that the downtown portion of the City is situated at an elevation of approximately 740 feet, NGVD 1929. There is an unnamed hill approximately one mile northwest of downtown Lowell that rises to an elevation of 1,105 feet. Butte Disappointment, which has a maximum elevation of 2,139 feet, is located approximately 1.15 miles northeast of downtown. The maximum ground surface elevation within the present City Limits is approximately 1,230 feet at a point on the southwest face of Butte Disappointment.

3.2 Physical Environment

The following subsection provides information about the physical environment in and around the City of Lowell as relates to stormwater collection planning.

3.2.1 Climate

The climate in Lowell is moderate. Summers are fairly warm, and winters are cool, but snow and freezing temperatures are not common. Average high temperatures are 48° F in January and 80° F in July. The annual mean temperature is approximately 63° F. Extreme temperatures range from 3° F to 106° F. Wind rose plots published by the Oregon Climate Service from measurements taken at the Eugene Airport indicate that prevailing winds in the area are from the north-northwest from May to September. Winds are generally from the southeast during the winter and early spring months. Average wind velocities range from 8.6 mph in the winter to about 8.5 mph in the summer.

Records from the weather station at the Lookout Point Dam weather station indicated that for the period from 1956 to 2005 the average annual precipitation in Lowell is approximately 45 inches. Nearly all the precipitation occurs as rainfall, with the majority (approximately 72%) falling between the months of October and March. The average rainfall between November and January was over 19 inches for this period of record. December is the wettest month with an average of approximately 6.8 inches. Records from the stated period also indicate a maximum 24-hour rainfall occurrence of 5.5 inches in the month of November. The driest month is July with an average of about 0.4 inches of rainfall. Figure 3-1 provides a graphical representation of monthly average rainfall amounts for the area based on data from the Lookout Point Dam during the 1956 to 2005 period.

Figure 3-1: Monthly Mean Precipitation
1956 to 2005

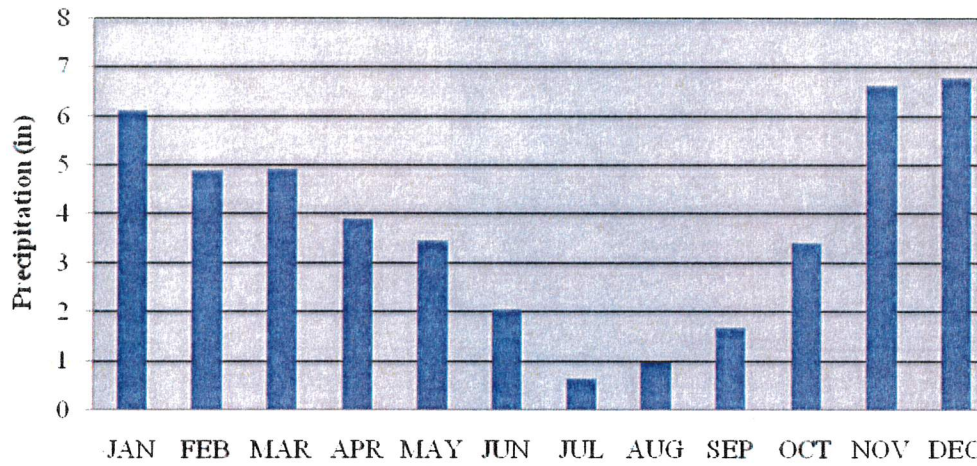
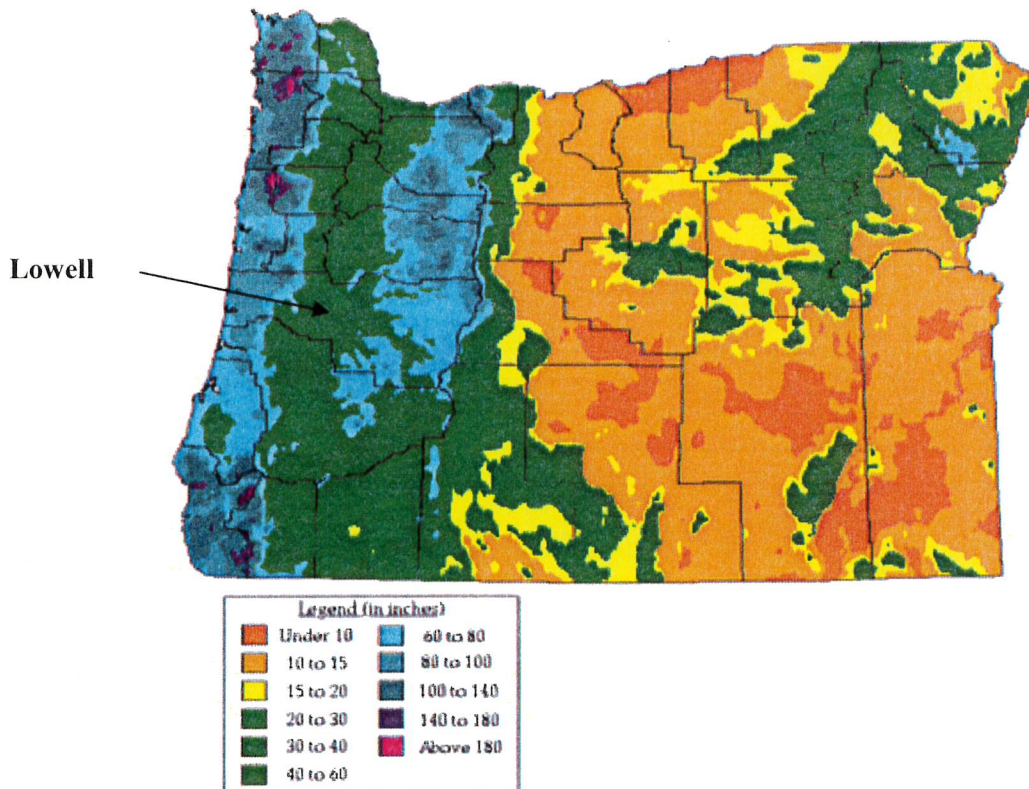
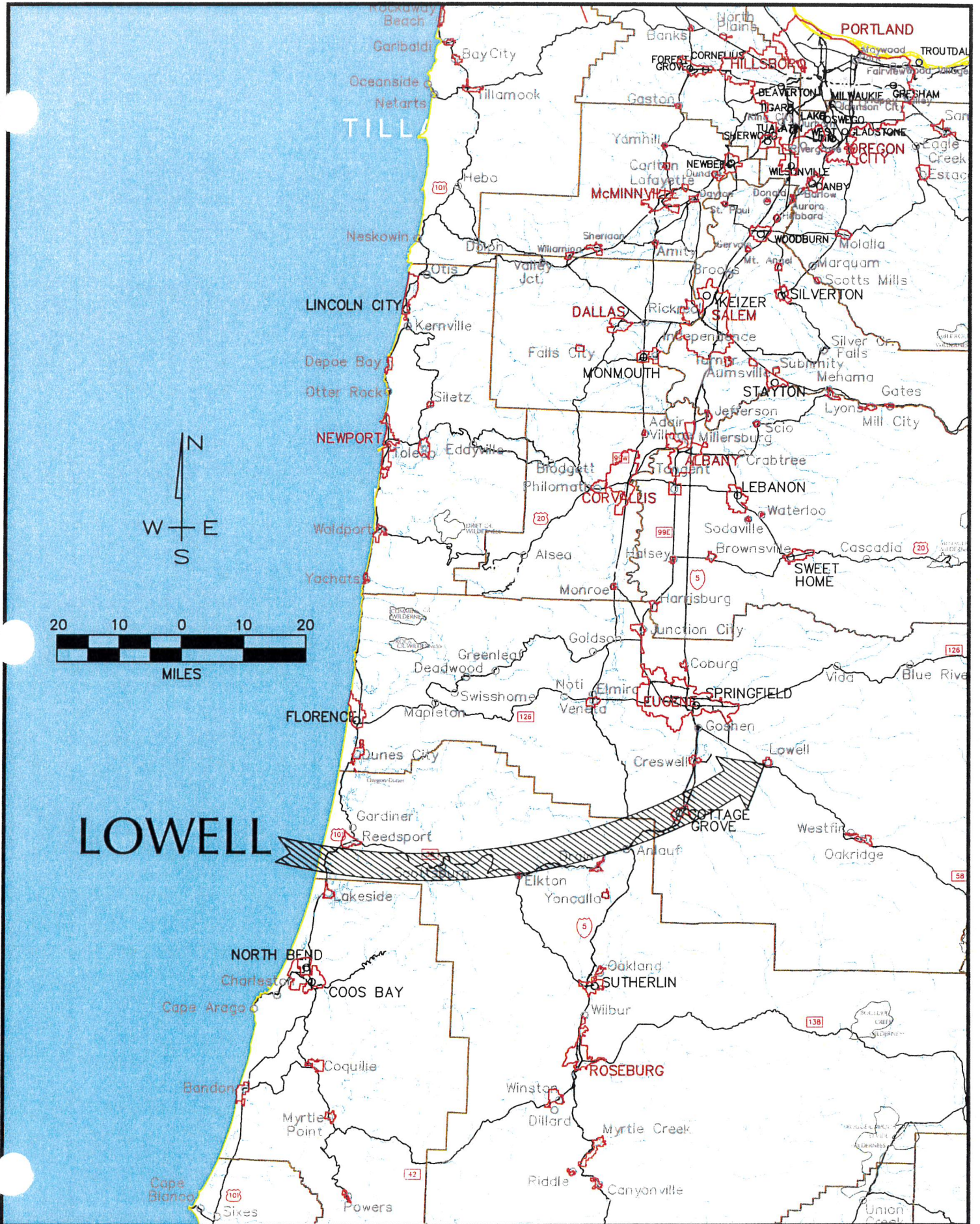

Figure 3-4 below indicates statewide average annual precipitation totals. Lowell is located in a zone identified as receiving an average of 40 to 60 inches annually.

Figure 3-2: Average Annual Precipitation

Source: Spatial Climate Analysis Service, Oregon State University, 2000





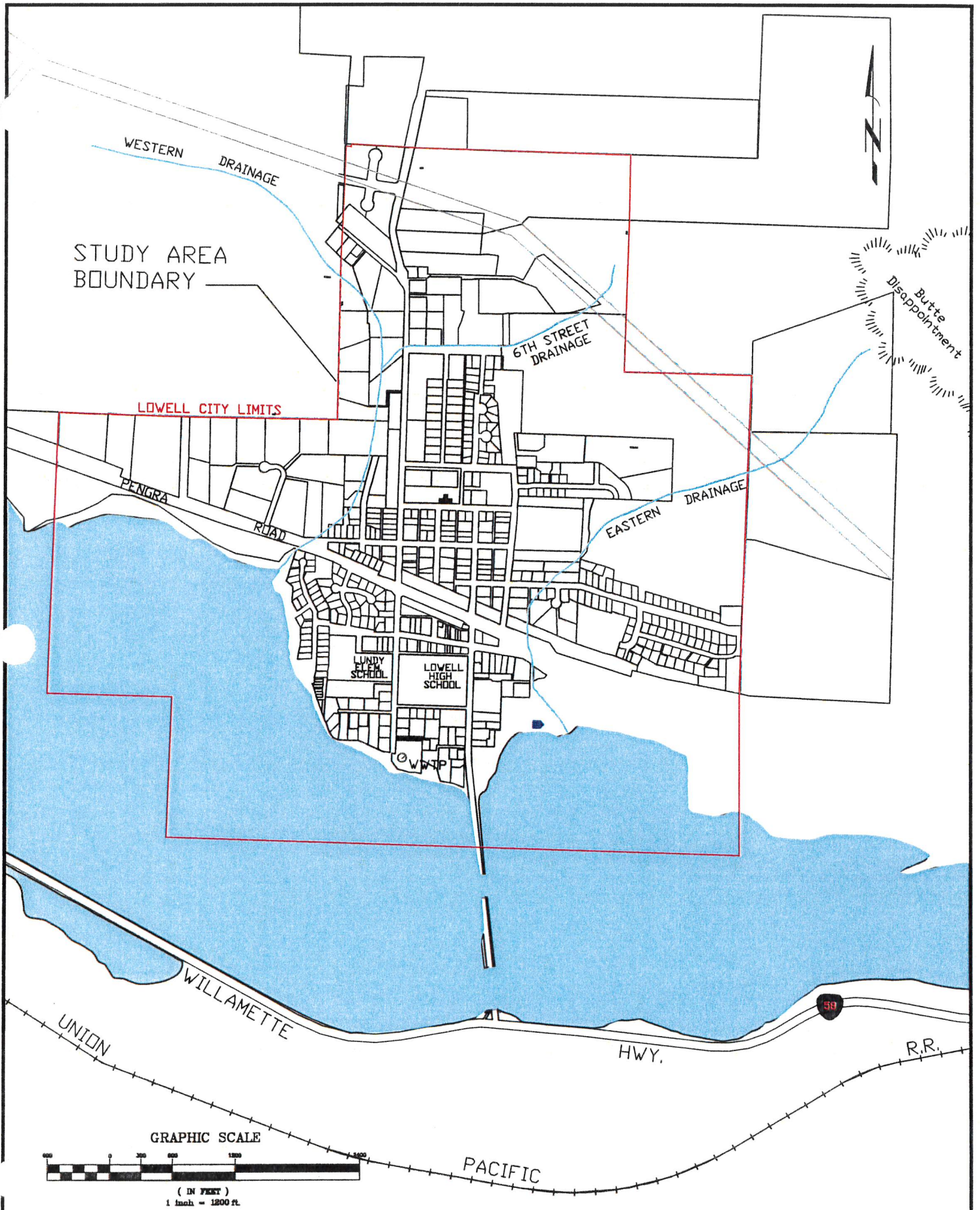

3.2.2 Soils and Geology

The City of Lowell is located within the transitional area between the Willamette Valley and Western Cascade Geologic and Physiographic Provinces. These two geologic subdivisions contrast in several aspects of their geologic history. In the Western Cascade Range the hill slopes are underlain by intrusive rocks, lava flows, and tuffs which were formed ten to 35 million years ago. Since then erosion has been the dominant geological process as streamcutting and landsliding have sculptured the major valleys and surrounding rugged hills and buttes. Consequently, the valley floor is filled with river sediments.

Soil properties greatly influence stormwater runoff and play an important role in groundwater recharge. Information pertaining to soil types and characteristics were obtained from the Natural Resource Conservation Service Lane County Soil Survey (NRCS, 1987). Soils within the Lowell area are dominated by silty clay loam. Over 60% of the area soil is classified as type "D" hydrologic soil indicating a very slow infiltration rate and high shrink-swell potential. Permeability of the remaining soils ranges from slow to moderate. Erosion potential of the area soils is generally slight to moderate except where surface slopes are 30% or more.

Soils covering the slopes surrounding Lowell are composed of shallow clays over moderately shallow, weathered rock. Soils within the developed area of Lowell consist generally of dense clays with natural stability hazards, such as small, active slumps, evident along the incised drainage channels, and silty clay soils which present drainage problems. A Soils Map is presented in Figure 3-5.

3.2.3 Geologic Hazards

Geologic hazards in Lowell include flooding and landslides. A discussion of each hazard and the areas it affects is presented below.

- **Flooding**

The U.S. Army Corps of Engineers has built flood control dams on the Middle Fork of the Willamette River and on Fall Creek. These structures control the flooding in the area, which was once an active flood plain. The City participates in the federal National Flood Insurance Program and has adopted Flood Hazard standards and policy, however the impacts of flood hazards are minimal within the City of Lowell. According to the Flood Insurance Rate Map for Lowell, the only land within Lowell that is within Zone A is Dexter Reservoir itself and the shoreline areas to the elevation of the top of the Dexter Dam. This land is entirely within the US Army Corps of Engineers jurisdiction.

The City borders the north shore of Dexter Lake and is surrounded by hills on all other sides; the resulting topographic configuration creates a short drainage basin which funnels the runoff through the community to the reservoir. Since most of the development within the City occurs on a relatively flat bench overlooking the lake, there are problems associated with runoff water topping channel banks through this area causing short-term localized flooding in some areas of the City.

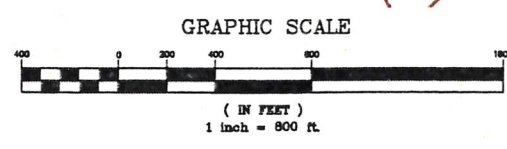
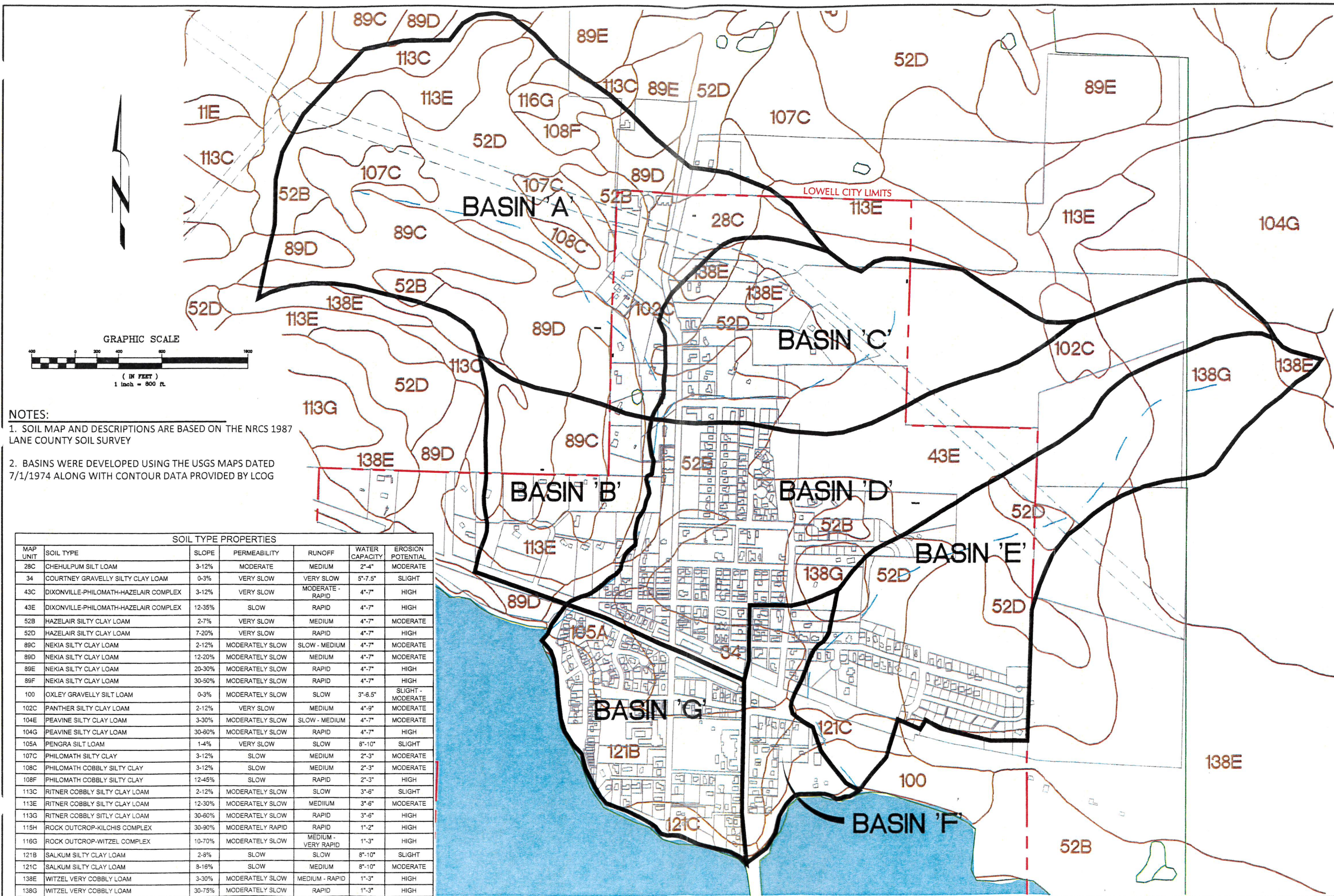

- NOTES:**
1. SOIL MAP AND DESCRIPTIONS ARE BASED ON THE NRCS 1987 LANE COUNTY SOIL SURVEY
 2. BASINS WERE DEVELOPED USING THE USGS MAPS DATED 7/1/1974 ALONG WITH CONTOUR DATA PROVIDED BY LCOG

SOIL TYPE PROPERTIES						
MAP UNIT	SOIL TYPE	SLOPE	PERMEABILITY	RUNOFF	WATER CAPACITY	EROSION POTENTIAL
28C	CHEHUPM SILT LOAM	3-12%	MODERATE	MEDIUM	2"-4"	MODERATE
34	COURTNEY GRAVELLY SILTY CLAY LOAM	0-3%	VERY SLOW	VERY SLOW	5"-7.5"	SLIGHT
43C	DIXONVILLE-PHILOMATH-HAZELAIR COMPLEX	3-12%	VERY SLOW	MODERATE - RAPID	4"-7"	HIGH
43E	DIXONVILLE-PHILOMATH-HAZELAIR COMPLEX	12-35%	SLOW	RAPID	4"-7"	HIGH
52B	HAZELAIR SILTY CLAY LOAM	2-7%	VERY SLOW	MEDIUM	4"-7"	MODERATE
52D	HAZELAIR SILTY CLAY LOAM	7-20%	VERY SLOW	RAPID	4"-7"	HIGH
89C	NEKIA SILTY CLAY LOAM	2-12%	MODERATELY SLOW	SLOW - MEDIUM	4"-7"	MODERATE
89D	NEKIA SILTY CLAY LOAM	12-20%	MODERATELY SLOW	MEDIUM	4"-7"	MODERATE
89E	NEKIA SILTY CLAY LOAM	20-30%	MODERATELY SLOW	RAPID	4"-7"	HIGH
89F	NEKIA SILTY CLAY LOAM	30-50%	MODERATELY SLOW	RAPID	4"-7"	HIGH
100	OXLEY GRAVELLY SILT LOAM	0-3%	MODERATELY SLOW	SLOW	3"-6.5"	SLIGHT - MODERATE
102C	PANTHER SILTY CLAY LOAM	2-12%	VERY SLOW	MEDIUM	4"-9"	MODERATE
104E	PEAVINE SILTY CLAY LOAM	3-30%	MODERATELY SLOW	SLOW - MEDIUM	4"-7"	MODERATE
104G	PEAVINE SILTY CLAY LOAM	30-60%	MODERATELY SLOW	RAPID	4"-7"	HIGH
105A	PENGRA SILT LOAM	1-4%	VERY SLOW	SLOW	8"-10"	SLIGHT
107C	PHILOMATH SILTY CLAY	3-12%	SLOW	MEDIUM	2"-3"	MODERATE
108C	PHILOMATH COBBLY SILTY CLAY	3-12%	SLOW	MEDIUM	2"-3"	MODERATE
108F	PHILOMATH COBBLY SILTY CLAY	12-45%	SLOW	RAPID	2"-3"	HIGH
113C	RITNER COBBLY SILTY CLAY LOAM	2-12%	MODERATELY SLOW	SLOW	3"-6"	SLIGHT
113E	RITNER COBBLY SILTY CLAY LOAM	12-30%	MODERATELY SLOW	MEDIUM	3"-6"	MODERATE
113G	RITNER COBBLY SILTY CLAY LOAM	30-60%	MODERATELY SLOW	RAPID	3"-6"	HIGH
115H	ROCK OUTCROP-KILCHIS COMPLEX	30-90%	MODERATELY RAPID	RAPID	1"-2"	HIGH
116G	ROCK OUTCROP-WITZEL COMPLEX	10-70%	MODERATELY SLOW	MEDIUM - VERY RAPID	1"-3"	HIGH
121B	SALKUM SILTY CLAY LOAM	2-8%	SLOW	SLOW	8"-10"	SLIGHT
121C	SALKUM SILTY CLAY LOAM	8-16%	SLOW	MEDIUM	8"-10"	MODERATE
138E	WITZEL VERY COBBLY LOAM	3-30%	MODERATELY SLOW	MEDIUM - RAPID	1"-3"	HIGH
138G	WITZEL VERY COBBLY LOAM	30-75%	MODERATELY SLOW	RAPID	1"-3"	HIGH

- **Erosion and Landslides**

Portions of the area surrounding Lowell have, in recent years, shown a high potential for landslides. The slide on the east face of Eagle Rock that displaced Highway 58, the southern Pacific Railroad line, and a number of buildings occurred after waste material from the quarry was deposited on the slide area. Other slides have been experienced near the north abutment of Lookout Point Dam in unstable deposits of natural slope debris and excavated waste material. Numerous small failures have been noted in connection with construction activity in deeply weathered tuffs of the Little Butte formation.

3.2.4 Water Resources

Dexter Lake is the last impoundment on the Middle Fork of the Willamette before it joins the coast Fork to create the main stem of the Willamette and is bordered by Dexter and Lookout Point dams. Dexter Lake covers 960 acres at minimum lower pool (690.0 ft) and 1,025 acres when full (695.0 ft). The lake is 3.3 miles in length and has a circumference of 7.3 miles with a drainage area of 991 square miles. Dexter Lake has a regulating dam that works in conjunction with Lookout Point Reservoir resulting in quite stable surface level that varies by only 5 feet year round. The only withdrawals from full pool are those required to regulate the varying power releases from Lookout Point powerhouse to fairly uniform flows downstream of Dexter Dam. The shores of these reservoirs, including the riparian areas, and dams are owned and operated by the United States Army Corps of Engineers, limiting the City's authority over the reservoir and lands directly adjacent to the reservoir.

Dexter Lake serves as the source water for the municipal supply. There are also several seasonal waterways that flow through Lowell. These drainages are used for stormwater conveyance and discharge into Dexter Lake. Effluent from Lowell's wastewater treatment plant is discharged into Dexter Lake just upstream of the dam.

3.2.5 Flora and Fauna

Vegetation quantity and type influence the volume of and rate at which runoff will occur. Logging, dam and road construction, farming and grazing have altered the vegetation found in the area. Most obvious is the lack of mature forest within forest zone areas adjacent to the City. There are some indigenous plant communities on the few relatively undisturbed sites surrounding Lowell, including Oak, Douglas fir, Incense Cedar and Western Red Cedar. Riparian and aquatic vegetation are found on the banks surrounding Dexter Lake. While the surrounding area is rich in its diversity of vegetation, only scattered groves of evergreen and deciduous trees are present within the City Limits and the remaining undeveloped land is covered with native grasses.

Presently, there are no known rare or endangered species of wildlife residing within Lowell and no areas of vegetative cover has been identified as being essential to the survival of any wildlife species commonly found in the Lowell area. While wildlife habitats in the community are scarce, water-fowl, shore birds, and upland game may be found along the northeastern shore of Dexter Lake; quail may be found on the extreme southeastern shore. The lake is used heavily for winter resting and feeding by numerous migratory birds. Some waterfowl nesting occurs mainly around the eastern portion of the lake. Many species of nongame birds use the habitats along the lake shore. Fur-bearing mammals using the lake margins include muskrat, beaver, mink, and occasionally otter.

Fish in Dexter Lake include largemouth bass, brown bullhead, and white crappie. Neither Dexter Dam nor Lookout Point Dam has a fish ladder, making this section of river impassable for salmon. The native run of salmon has been extinct on this river since the 1950s when the dams were built.

3.3 Socio-Economic Environment

3.3.1 Economic Conditions and Trends

Lowell was a timber town until the late 1980s. The early industries in the area were hop raising, stock raising, and logging. The first sizable increase in population occurred in conjunction with the building of the Lookout Point Reservoir by the U.S. Army Corps of Engineers (Corps) in 1948.

A slightly dated economic profile of Lowell is available from the Region 2050 report, published in 2000 by the Lane Council of Governments (LCOG). In 1998, there were 148 jobs in Lowell. The primary sources of employment in the City include the U.S. Forest Service, two predominant local manufacturers, local schools, and several small retailers. The aforementioned manufacturers are Eagle Rock Logging and Tumac Industries (a fabricator of custom metal products), each with about 20 employees. Consolidation of the USFS District offices substantially reduced the workforce in the Lowell office. The vast majority of workers that live in Lowell must commute to Eugene-Springfield for employment.

Although an imminent demand for industrial land was not identified in Lowell's 2005 Comprehensive Plan, the community decided to reserve an inventory of land for manufacturing/research activities in the event that such a need arises. Also, Lowell has established an industrial park to which city services have been extended, and space exists for as many as four more businesses to locate there. Finally, Lowell seeks to capitalize on its natural beauty, recreational assets, small-town character, and available land to draw in companies that desire to locate in an attractive environment.

3.3.2 Population

The U.S. Census Bureau collects and reports data on population and demographics every decade. In the year 2000, the City of Lowell was reported to have a population of 880 and a total of 342 housing units, of which 315 units were occupied, yielding an average of 2.79 persons per household. Based on census data, the average annual population growth rate between 1990 and 2000 was 1.15% per year.

Note: Initially, the U.S. Census report in 2000 had determined the population of Lowell to be 857. That figure was disputed and later changed to 880.

Table 3-1 – County and City Historical Population

Year	Lane County Population	City of Lowell Population
1960	162,890	503
1970	215,401	567
1980	275,226	661
1990	282,912	785
2000	322,959	880

Source: U.S. Census Bureau – Decennial Population and Housing Reports

The 2006 Oregon Population Report published by the Population Research Center at Portland State University (PSU) estimated the population of the City of Lowell at 955 as of July 1, 2006. Based on population estimates by PSU, the average annual growth rate within the City of Lowell between 2000 and 2007 was 1.77% per year.

Table 3-2 – County and City Historical Estimates

Year	Lane County Population	City of Lowell Population
2000	323,950	880
2001	325,900	880
2002	328,150	880
2003	329,400	890
2004	333,350	900
2005	336,085	920
2006	339,740	955
2007	343,140	995

Source: PSU Population Research Center – Annual Oregon Population Reports

The Lane Council of Governments (LCOG) developed the Lane County Coordinated Population Projections, adopted February 24, 2005, for all incorporated cities within the County as a basis for municipal infrastructure planning. Historical population trends coupled with an analysis of the availability of buildable land and municipal services were used to determine likely population growth rates for a given period. The growth rate originally adopted by LCOG for the City of Lowell results in a 2030 population of 1,700, which is equivalent to a 2.22% average annual growth rate (AAGR) based on the year population 880.

In December 2006, the City of Lowell submitted a request to LCOG to adopt an increased 4.62% AAGR to project population through the year 2030. In June 2007, the City provided supporting information from a variety of sources justifying the requested increase, including population projections completed by Johnson Gardner, LLC. In their report, Johnson Gardner, LLC supported the increase to the overall growth rate by noting that Lowell is a similar distance from Eugene/Springfield as Veneta and Cresswell which experienced average annual growth rates similar to the AAGR requested by Lowell. Based on the continued need for affordable housing within reasonable driving distance from Eugene/Springfield area, it is logical to conclude that Lowell could experience growth rates nearly equal to its outlying counterparts elsewhere in the county. Based on the 2007 population estimate of 995, the requested growth rate results in a year 2030 population of 2,812.

At the direction of City officials, this analysis evaluates the City’s existing stormwater infrastructure and its future drainage needs to accommodate population growth at the suggested 4.62% growth rate. Although this value is higher than historic and recent growth rates within the County and City, it is pointed out that it is preferable to be slightly conservative when adopting growth rates (i.e., avoid underestimation of population growth). The following table presents population estimates based 4.62% AAGR proposed by the City of Lowell.

Table 3-3 – Population Projections

	2007	2008	2013	2018	2028
City of Lowell	995	1041	1,305	1,635	2,569

3.4 Land Use

Land use in the City of Lowell is typical of urban areas with zones including high and low density residential, commercial, industrial, and public land. The City of Lowell’s 2005 Comprehensive Plan describes the existing pattern of development as low density with large amounts of vacant and partially vacant land scattered throughout the community. Much of the vacant property in the City is subject to one or more natural development limitations including steep slopes, drainageways, flood hazard, wetlands, riparian areas, and geologic or soil limitations. A Land Use Designation Map depicting current zoning is presented in Figure 3-6.

Residential districts comprise 76 percent of the City's Tax Lots. Within the City, 412.6 acres are presently designated for single-family dwellings (R1) and another 11.7 acres for multi-family dwellings (R3). There are 270 acres of vacant R-1 land of which only 66 acres are unconstrained for residential development. Existing multi-family residential uses currently account for 2 acres of developed land in Lowell.

General Commercial (C1) zoning is concentrated along Lowell's major collector roadways, Pengra Road and Moss Street. Lots zoned Downtown Commercial (C2) front on Main Street one block south of Pengra Road. General Commercial zoning comprises 10.7 acres within the City and Downtown Commercial accounts for 5.8 acres. The majority of the commercial land in Lowell is undeveloped or used as residential. Due to Lowell’s proximity to retail and service centers in Eugene and Springfield, it is expected that commercial development in Lowell will be limited until a larger population is achieved.

The Industrial District (I1) is located in the northwest section of the City and encompasses 10.2 acres. Of this, only two parcels totaling 3.78 acres are developed.

The Public Lands (PL) zone contains approximately 106.3 acres. Public uses include parks, schools, fire districts, water and wastewater treatment plants, and other governmental facilities. This land also includes the shoreline around Dexter Lake, which is under US Army Corp of Engineers jurisdiction.

Only 174 of the 445 tax lot acres within the City are developed and 271 are vacant or partially vacant. The UGB Land Analysis identified 204 acres as constrained vacant land leaving only 66 acres of unconstrained “Buildable Land”. Constrained Lands are 75% of the vacant land in the City and 46% of the City’s total Tax Lots. Table 3-4 lists acreage within the various land use categories from data presented in the referenced Comprehensive Plan.

Table 3-4: 2005 Land Use Summary

Land Use Category	Tax Lot Acreage ¹				Total Tax Lot Area
	Residential R-1 & R-3	Commercial C1 & C2	Industrial	Public Lands	
Developed	128.29	8.25	2.07	35.69	174.30
Vacant & Unconstrained	58.82	1.59	5.35	0.71	66.47
Constrained	204.00	0	0	0	204.00
Total Tax Lot Area	391.11	9.84	7.42	36.40	444.77

¹Tax lot acres exclude areas land area used for roads

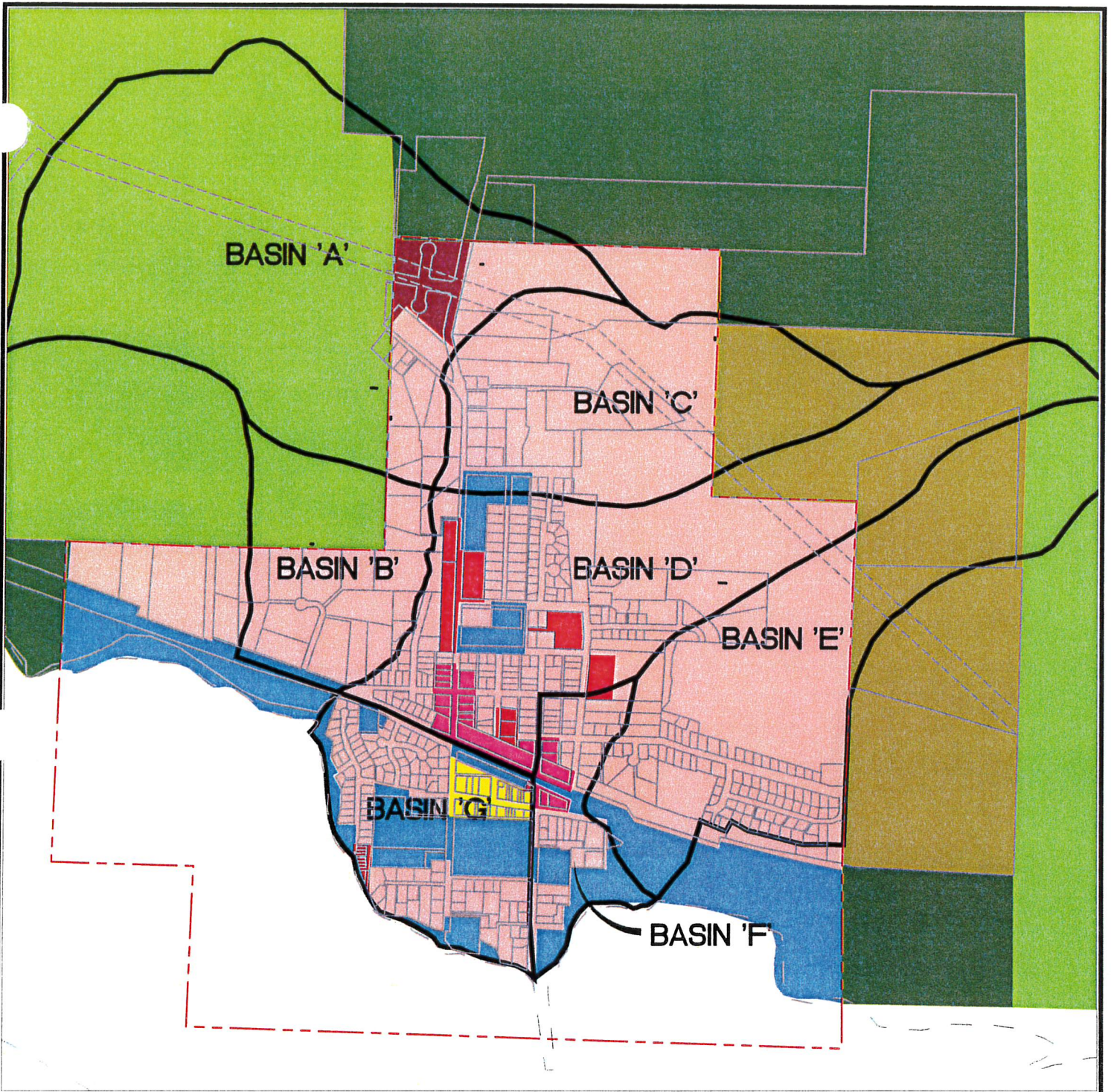

LEGEND

CITY LAND USE ZONING:

- RESIDENTIAL SINGLE FAMILY (R1)
- RESIDENTIAL MULTI-FAMILY (R3)
- GENERAL COMMERCIAL (C1)
- DOWNTOWN COMMERCIAL (C2)
- INDUSTRIAL (I1)
- PUBLIC LANDS (PL)

COUNTY LAND USE ZONING:

- NONIMPACTED FOREST LAND (F1)
- IMPACTED FOREST LAND (F2)
- EXCLUSIVE FARM USE - 40 ACRES (E40)



GRAPHIC SCALE



(IN FEET)
1 inch = 1200 ft.

3.4.1 Drainage Basins

A total of 7 separate storm drainage basins have been identified within the study area. These basins were defined using US Geological Survey (USGS) maps along with contour data provided by LCOG. Some of the basins have been further divided into subbasins for modeling purposes. Table 3-5 below presents data by basin.

Table 3-5: Drainage Basin Characteristics

Basin	Basin Area (acres)	Basin Area Within City Limits (acres)	Land Use
A	234.0	38.4	13% Single Family Residential (R1) 4% Industrial (I1) 83% Outside City Limits – Forest
B	60.4	39.5	62% Single Family Residential (R1) 3% Public Lands (PL) 35% Outside City Limits – Meadows/Forest
C	107.6	82.1	72% Single Family Residential (R1) 26% Outside City Limits – Meadows/Forest
D	166.2	120.7	56% Single Family Residential (R1) 6% Multi-Family Residential (R3) 5% General Commercial (C1) 28% Outside City Limits – Meadows/Forest
E	150.9	95.2	58% Single Family Residential (R1) 5% Public Lands (PL) 37% Outside City Limits – Meadows/Forest
F	26.6	26.6	52% Single Family Residential (R1) 1% Multi-Family Residential (R3) 10% General Commercial (C1) 1% Downtown Commercial (C2) 36% Public Lands (PL)
G	56.9	56.9	51% Single Family Residential (R1) 1% Multi-Family Residential (R3) 1% General Commercial (C1) 9% Downtown Commercial (C2) 38% Public Lands (PL)

3.4.2 Equivalent Dwelling Unit (EDU) Methodology

In order to evaluate the storm drain system capacity required by each individual property within a drainage area, it is necessary to establish a method for comparing properties based on their contribution to the total runoff. In essence, each property within a drainage area has a percentage of ownership of the storm drain infrastructure serving that area and therefore is responsible for a portion of the costs of maintaining those facilities. This section explains the rationale for assigning such responsibility to each property.

Storm drainage facilities are sized based on calculations of runoff expected from the area served for a given design storm, for instance the 25-year design storm. Hydrologic analysis of the study area and design storm selection for runoff calculations are discussed in Section 5 of this report. Runoff occurs at differing rates depending on the type of ground cover, i.e. forest, lawn, paved roadways, roofs, etc. Under natural conditions, a portion of the rainfall is absorbed into the ground. In densely developed areas, much of the rainfall that occurs results in direct runoff due to the impervious nature of surfaces including, roadways, sidewalks, driveways, roofs, and patios. The amount of runoff from an area is, among other factors, a function of the amount of impervious surface within that area.

There are approximately 349 single family homes within the study area. In most instances, duplexes have been counted as two homes when it appears they have nearly equivalent impervious area to that of two detached homes. Other multi-family dwellings, as well as schools, churches, most businesses, and any other buildings larger than a home or sites with paved parking areas, have been accounted for under the column for Commercial/Other. An in-depth analysis of 20 residential homes on "D" Street between 4th and 6th streets has resulted in the conclusion that an average dwelling in the study area includes a building footprint of approximately 1,800 square feet plus an additional 1,000 square feet of driveway and walkways. Therefore, the total impervious area allotted to one average residence is 2,800 square feet.

For the purposes of this Master Plan, an Equivalent Dwelling Unit (EDU) will be used as the standard unit of measure for calculation of the cost sharing of storm drainage improvement projects. Each single family home, including manufactured homes, will be considered one EDU. Duplexes will be considered two EDU's. All other multiple residential, commercial, industrial and public buildings will have EDU's calculated by dividing the total impervious area on the property by 2,800 square feet. The following table summarizes the number of existing EDU's per basin:

Table 3-6: Existing EDU's per Drainage Basin

Basin	EDU's Homes	EDU's Commercial/Other	Total EDU's
A	10	21	31
B	12	0	12
C	19	14	33
D	128	46	174
E	39	0	39
F	32	12	44
G	109	56	165
Total	349	149	498

3.4.3 Future EDU's

The analysis of existing and expected future land use within the City of Lowell has resulted in the determination of future storm drain system capacity requirements based on an increase in the number of EDU's anticipated within the study area. For the purpose of this study, it has been assumed that EDUs will grow at the same rate as the population or 4.62% annually over the next 20-years. Based on this assumption an estimated 789 EDUs will be developed within the City by 2028 for a total of 1288 future EDU.

In order to project future system needs, the 789 additional EDUs that will be generated over the next 20 years were divided between the various basins. However, since potential development opportunities vary among the basins the new EDUs were not uniformly allotted to each basin. The highest percentage of new EDUs is expected to occur where there currently exist large areas of undeveloped land. Conversely, in areas that are already at or near full development fewer future EDUs can be absorbed into the basin. Table 3-7 provides a summary of the expected EDU increase on a percentage basis for each Basin.

Table 3-7: Basins' Percentage of Projected New EDUs

Basin	A	B	C	D	E	F	G
Portion of Future EDUs	10%	0.5%	23%	30%	30%	2.5%	4%

The number of future EDUs has been calculated for each Basin as of the planning year 2028 based on the percentage growth per Basin as indicated in Table 3-7 above. Additional increases in EDUs also have been determined for buildout conditions for each Basin. The following table provides a summary of the expected EDU increases by Basin for both the year 2028 and for buildout conditions.

Table 3-8: Future EDU's per Drainage Basin

Basin	Existing EDU's	Year 2028		Buildout	
		Projected New EDU's	Total Future EDU's	Projected New EDU's	Total Future EDU's
A	31	79	110	79	110
B	12	4	16	4	16
C	33	181	214	191	224
D	174	237	411	239	413
E	39	237	276	249	288
F	44	20	64	22	66
G	165	31	196	37	202
Total	498	789	1287	821	1319

The above table summarizing future EDU's has been developed for use in the City's System Development Charge (SDC) Plan.

Stormwater Master Plan

Chapter 4

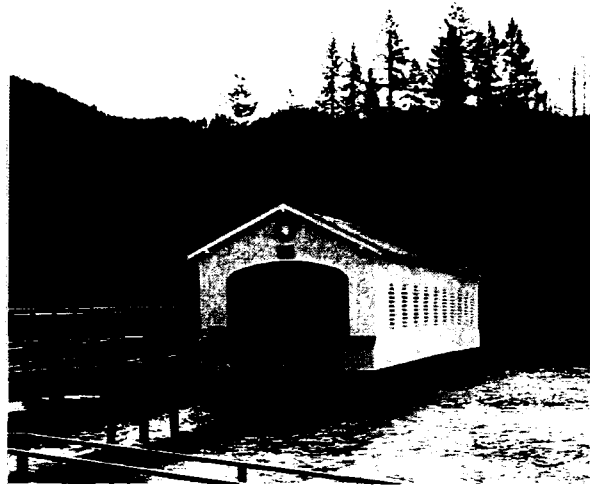

4.0 Existing Stormwater Facilities

4.1 *General*

This Section provides a brief description of the existing storm drain facilities within the City of Lowell. A system inventory was generated using information obtained from City and Lane County "as-built" drawings for various storm drainage improvement projects within the City. This information was supplemented by City personnel knowledge pertaining to the storm drain systems and by field reconnaissance conducted by HBH Consulting Engineers.

The study area has been divided into seven storm drainage basins delineated based on surface topography shown on USGS maps and contour data provided by Lane Council of Governments (LCOG). An Overall Basin Map indicating the various drainage basins within the study area is presented in Figure 4-1. These main basins were further divided into 24 sub-basins due to various drainage routes, land use, and surface conditions.

4.2 *Information Gathering and Sources*

The City of Lowell did not previously have a complete map of existing storm drainage facilities. As part of the scope of this Master Plan, a Storm Drain System Map has been developed (included at the back of this Master Plan). Much of the information used in the system inventory shown in the base map was provided by City personnel and a site survey of the system to determine size and condition of a number of storm drain pipe, outfalls and culverts within the system. Additional information has been obtained from record drawings for County road improvements and housing developments.

4.3 *Storm Drainage System Overview*

The City of Lowell is situated in a narrow finger of the southern Willamette Valley formed by the Middle Fork of the Willamette River. The City borders the north Shore of Dexter Lake and is surrounded by hills on all other sides. The resulting topographic configuration creates a short drainage basin which funnels the runoff through the community to the lake. Since most of the development within the City occurs on a relatively flat bench overlooking the lake, there are problems associated with channeling excess surface water through this area. A general description of the various stormwater drainage basins and discharge points is presented below.

4.3.1 Basin A

Basin A encompasses 234 acres in the northwest portion of Lowell. The westerly portion of this basin is situated between two unnamed hills whose peaks are approximately one-half mile westerly of the City Limits. The easterly portion of this basin extends north to the top of the rise along Jasper-Lowell Road which is located approximately 700 feet north of Seneca Street and south to a point approximately 300 feet southwest of the intersection of Moss and 6th Streets at which an existing drainage along 6th Street joins the Western Drainage. Most of Basin A lies to the west of Moss Street, however, higher land generally north of Seneca Street drains to the west across Moss Street and is therefore included. The maximum elevation within Basin A is 1187 feet at the top of the northerly hill; the minimum elevation is approximately 748 feet.

The bulk of Basin A (84%) lies outside the City Limits on the described hillside property which is part of a larger undeveloped parcel owned by Seneca Timber Company. The Seneca property is zoned Nonimpacted Forest Land (F1) by Lane County and has traditionally been used for timber production. Ground cover includes a combination of forest and meadows. The remaining land outside the City Limits is zoned Impacted Forest Land (F2) and supports several rural residences on large lots. Ground slopes on land outside the City Limits ranges from about 3% in low lying areas to as much as 30% on the hills.

The portion of Basin A (16%) that lies within the City Limits includes 9.3 acres of Industrial (I1) zoned land and 32.6 acres zoned Single Family Residential (R1). Ground slopes within the City Limits generally range from 2 to 10 percent. Much of this area is presently undeveloped but is expected to develop over the next 20 years and beyond as housing demand increases. Several wetland areas are identified on mapping provided by LCOG and National Wetland Inventory mapping within the portion of Basin A lying inside the City Limits.

Soils within Basin A include Chehulpum silt loam (28C), Hazelair silty clay loam (52B & D), Nekia silty clay loam (89C, D & E), Panther silty clay loam (102C), Philomath silty clay (107C), Philomath cobbly silty clay (108C & F), Ritner cobbly silty clay loam (113C & E), Rock Outcrop – Witzel Complex (116G), and Witzel very cobbly loam (138E). The permeability of these soil types ranges from very slow to moderate with runoff rates generally ranging from slow to rapid.

Stormwater generated within Basin A collects in an unnamed creek, indentified in this plan as the Western Drainage, which enters the City limits from the west just south of 7th Street. Stormwater flows begin as overland sheet flow in the uppermost elevations of Basin A, gather into shallow concentrated flows as they descend the described hillsides, and eventually collect into the Western Drainage.

Stormwater north of Seneca Street is collected in one of four catch basins and conveyed through a series of culverts and trenches to a 0.75 acre pond located approximately 130 feet south of Industrial Parkway. A ditch connecting the pond to the Western Drainage captures the surrounding area runoff. Runoff east of Moss Street and south of Seneca Street enters into a drainage ditch that runs on the east side of Moss Street and continues into Basin C. The remaining stormwater on the west side of Moss Street drains through the wetlands and into the Western Drainage.

4.3.2 Basin B

Basin B encompasses approximately 60.4 acres in the southwest portion of Lowell. The basin is located on the southeasterly slope of the southerly of two unnamed hills whose peaks are approximately one-half mile west of the City Limits. The westerly boundary of this basin runs north-south along a flank of the

described hill terminating at Pengra Road on the south. The southerly boundary of Basin B is along Pengra Road from a point approximately 1,900 feet westerly of Moss Street to approximately 1,000 feet west of Moss Street. The east boundary of this basin is along the Western Drainage from Pengra Road north to a point located approximately 300 feet southwest of the intersection of Moss and 6th Streets. The highest point in Basin B is approximately 920 feet and the lowest point is approximately 698 feet. Ground slopes in this basin range from 2% to over 45% on portions of the described hill.

The northwesterly 21 acres of the Basin B is located outside the City Limits and is undeveloped. Runoff within this basin is to the south or east, depending on location, and ultimately flows into the Western Drainage. Runoff from the subdivision along Marina Vista Drive is conveyed along the north side of Pengra Road to the Western Drainage. At the southeast corner of the sub-basin, the Western Drainage passes through a 72-in by 48-in concrete culvert, named the "Love Canal", before discharging into Dexter Lake.

Basin B includes approximately 37.6 acres of land zoned Single Family Residential (R1). The lots in this portion of town are generally on the order of 2 acres. Most of the lots are developed at this time, with only four remaining lots available for development. The portion of this basin lying outside of the City Limits is part of the Seneca Timber Company property described in the previous subsection and is zoned Nonimpacted Forest (F1).

Soils within Basin B include Nekia silty clay loam (89C & D), Panther silty clay loam (102C), and Ritner cobbly silty clay loam (113C & E). The Nekia and Ritner soils dominate the southeast slope of the above described hill. Panther soils are present along the low lying areas surrounding the Western Drainage.

4.3.3 Basin C

Basin C encompasses 107.6 acres in the northeastern corner of Lowell. Approximately 25.5 acres of the basin lie outside the City Limits extending onto the western slope of Butte Disappointment. The northerly and southerly boundaries of Basin C are along adjacent ridgelines located on the lower westerly flanks of the mountain. The westerly boundary of the basin lies approximately 150 feet west of Moss Street and is roughly parallel to the roadway. One of the City's unnamed seasonal creeks, named here as the "6th Street Drainage", bisects the basin. The upper portion of the 6th Street Drainage is a natural stream and the lower portion is ditched along the north side of 6th Street. The drainage connects with the Western Drainage approximately 250 feet southwest of the intersection of Moss and 6th Streets.

Basin C includes 79.8 acres of land zoned Single Family Residential (R1) and 2.3 acres zoned Public Lands (PL) within the City Limits. The bulk of the 25.5 acres located outside the City Limits is zoned Exclusive Farm Use (E40) by Lane County.

Soils within Basin C include Dixonville-Philomath-Hazelair Complex (43E) which is a mixture of silty clay loam and cobbly silty clay soils, Hazelair silty clay loam (52B & D), Panther silty clay loam (102C), and Witzel very cobbly loam (138E).

Stormwater from the easterly portion of Basin C flows westerly down the slopes of Butte Disappointment and collects in the upper portion of the 6th Street Drainage. Runoff from the northerly portion of the basin flows to a smaller drainage which is piped under Moss Street and discharged into another drainage ditch along the west side of Moss Street just south of 7th Street. Runoff from the southwesterly portion of Basin C flows southwest, collects in the 6th Drainage system and is then transported under Moss Street through a 36-inch culvert. The 6th Street Drainage merges with the described drainage ditch along the west side of Moss Street at the outlet of the 36-inch culvert.

4.3.4 Basin D

Basin D encompasses 166.2 acres in the east-central portion of Lowell. Approximately 45.4 acres of the basin lies outside the City Limits extending up the western slope of Butte Disappointment. Basin D lies adjacent to Basin C on the south. The northerly and southerly boundaries of Basin D are along adjacent ridgelines located on the westerly slopes of the mountain. One of the City's unnamed seasonal creeks, named here as the "4th Street Drainage", collects runoff from within the basin. The upper portion of the 4th Street Drainage is a seasonal stream and the lower portion runs through a culvert along north side of 4th Street. It connects with the Western Drainage approximately 350 feet west of the intersection of Moss and 4th Streets.

Basin D includes 95.3 acres of land zoned Single Family Residential (R1), 10.5 acres zoned Multi-Family Residential (R3), 7.5 acres zoned General Commercial (C1), and 7.5 acres zoned Public Lands (PL) within the City Limits. Areas located outside the City Limits include 39.0 acres zoned Exclusive Farm Use (E40) and 6.4 acres zoned Nonimpacted Forest Land (F1) by Lane County.

Soils within Basin D include Courtney gravelly silty clay loam (34), Dixonville-Philomath-Hazelair Complex (43E) which is a mixture of silty clay loam and cobbly silty clay soils, Hazelair silty clay loam (52B & D), Panther silty clay loam (102C), Pengra silt loam (105A), and Witzel very cobbly loam (138G). The downtown area is dominated by Hazelair soils, while the slopes of Butte Disappointment are mainly comprised of Dixon-Philomath Hazelair Complex on the lower slopes and Witzel soils on the upper portion of the slopes.

Basin D has been divided into three subbasins for modeling purposes. Each subbasin has a different drainage path terminating at the Western Drainage. Subbasin D1 encompasses the majority of the area east of Moss Street and generally north of 4th Street. Stormwater runoff from Subbasin D1 follows the 4th Street storm drainage system described above. Subbasin D2 occupies the area bounded by Moss Street on the west, Hyland Drive on the east, Pengra Road on the south, and 4th Street on the north. Runoff from Subbasin D2 is collected in a storm drain system east of Moss Street, mainly along 3rd Street. Subbasin D3 includes the area west of Moss Street and north of Pengra Road. Runoff from Subbasin D3 occurs as overland sheet flow directly to the Western Drainage or passes through an open ditch as it approaches the Western Drainage.

Subbasin D1

Sub-basin D1 occupies 118.0 acres in the northwesterly portion of Basin D. It is generally bounded by 4th Street on the south and Moss Street on the west. The northerly and easterly boundaries are contiguous with the boundaries of Basin D as described above. This subbasin includes approximately 18 acres of developed residential land, about 7 acres of undeveloped land zoned for public use, and 93 acres that is undeveloped with the exception of a few residences.

Subbasin D2

Subbasin D2 occupies 28.8 acres in the southerly portion of Basin D. It is bounded on the south by Pengra Road, on the west by Moss Street, on the north by 4th Street, and on the east by Hyland Butte. This area is one of most heavily and diversely developed regions within Lowell. Of the area's 28.8 acres, approximately 5.2 acres are general commercial, 3.5 acres are zoned public lands, and 4.7 acres are multifamily residential. The remaining 15.5 acres are zoned single family residential.

Stormwater runoff from Subbasin D2 is collected in a series of ditches and culverts which direct flow to a storm drain system located on the east side of Moss Street. This drainage system crosses Moss Street at 3rd Street into sub-basin D3 through what is believed to be a 12" culvert. (The pipe outfall was overgrown with briars which should be cleared and the size verified).

Subbasin D3

Subbasin D3 occupies 19.4 acres in the western portion of Basin D. It is bordered by the Western Drainage on the west, Pengra Road on the south, and Moss Street on the east. A wetland surrounds the Western Drainage north of 4th Street. This sub-basin contains 2.4 acres zoned general commercial, 3.4 acres zoned multifamily residential, and 13.6 acres zoned single family residential. While the area north of 3rd Street is largely undeveloped, the southern portion of this sub-basin is fully developed.

Stormwater runoff from Subbasin D1 enters Subbasin D3 at 4th Street and is conveyed west through five 24-in conduits into the Western Drainage. Runoff from Subbasin D2 enters the subbasin at 3rd Street and runs west where it passes through two parallel 24-inch conduits at Damon Street before discharging into the Western Drainage, 450 feet south of the 4th Street outfall. Stormwater that is generated within sub-basin D3 drains directly into the Western Drainage or by way of the 4th or 3rd Street drainage.

4.3.5 Basin E

Basin E is located in the southeastern portion of the City and occupies 150.9 acres on the southwesterly slope of Butte Disappointment. Approximately 55.7 acres of Basin E lies outside the City Limits on the upper portion of Butte Disappointment. An unnamed perennial creek flows southwest through the basin and ultimately discharges into Dexter Lake. This creek is identified in this Master Plan as the "Eastern Drainage." A storm drainage system on East 1st Street collects runoff generated along the street and to the north, east of Trailblazer Court. This collection system is connected to a culvert that crosses 1st Street approximately 350 feet east of Hyland Drive. The Eastern Drainage then continues southerly, crosses an old railroad alignment through a concrete box culvert, and then crosses West Boundary Road through parallel 36-inch and 42-inch diameter concrete culvert pipes. Portions of Basin E south of 1st Street drain into the Eastern Drainage or directly into Dexter Lake.

Basin E is largely undeveloped at this time, although approximately 29 acres of residential subdivision have been completed in the southerly portion of the basin within recent years. Ground cover in undeveloped portions of this basin includes a mixture of grassy meadows, brush, and forested areas.

Soils within Basin E include Dixonville-Philomath-Hazelair Complex (43E), Hazelair silty clay loam (52D), Oxley gravelly silt loam (100), Salkum silty clay loam (121C), and Witzel very cobbly loam (138E & G). The lower slopes of Butte Disappointment are mainly comprised of Dixon-Philomath Hazelair Complex and Hazelair soils, while Witzel soils dominate the upper slopes.

For modeling purposes, Basin E has been divided into two subbasins. Subbasin E1 occupies the northern portion of the basin and corresponds to the watershed area of the Eastern Drainage north of 1st Street. Subbasin E2 is situated in the southern portion of the basin and corresponds to areas which either drain directly to Dexter Lake or contribute flows to the Eastern Drainage south of 1st Street.

Subbasin E1

Subbasin E1 encompasses 101.4 acres north of 1st Street. As indicated above, all runoff from this area collects within the Eastern Drainage north of 1st Street and passes through an existing 30-inch diameter corrugated metal pipe which crosses 1st Street approximately 350 feet east of Hyland Drive.

Zoning within the portions of Subbasin E1 that lie inside the City Limits includes 45.7 acres of Single Family Residential (R1). Portions of Subbasin E1 that lie outside the City Limits include 35.4 acres zoned Exclusive Farm Use (E40) and 20.3 acres zoned Nonimpacted Forest Land (F1) by Lane County. Subbasin E1 is primarily undeveloped at this time, although there are a few existing residences set back from 1st Street that lie within the subbasin.

Subbasin E2

Subbasin E2 includes 49.5 acres south of East 1st Street extending to the shore of Dexter Lake. Most of the stormwater generated in Subbasin E2 is collected in the Eastern Drainage, which discharges into Dexter Lake at a point approximately 400 feet east of Parker Lane. The remaining stormwater generated in the southeastern section of this subbasin bypasses the drainage and flows directly into the lake.

Zoning within Subbasin E2 includes 42.1 acres of Single Family Residential (R1) and 7.4 acres of Public Lands (PL). Present development within Subbasin E2 includes approximately 13.8 acres of single family homes along 1st Street and to the south. The remaining 28.3 acres zoned R1 along with areas zoned PL are undeveloped at this time.

4.3.6 Basin F

Basin F occupies 31.8 acres in the southeasterly portion of Lowell and is bordered by Pioneer Street on the west, 2nd Street on the north, and Dexter Lake on the south. The northeasterly corner of Basin F is located at the top of Hyland Butte. The easterly boundary of Basin F extends down the southwesterly slope of Hyland Butte to a point located approximately 50 feet east of the intersection of East Main Street and Pengra Road, and then turns southeast and extends to a point on the north shore of Dexter Lake approximately 400 feet east of Parker Lane. The majority of the runoff in this basin is conveyed by several storm drainage systems into the Eastern Drainage. Runoff in the southern portion of the basin discharges directly into Dexter Lake.

Soils in Basin F include Courtney gravelly silty clay loam (34), Hazelair silty clay loam (52D), Oxley gravelly silt loam (100), Salkum silty clay loam (121B & C), and Witzel very cobbly loam (138G). These soils range in permeability from moderately slow to very slow.

For modeling purposes, Basin F has been divided into two subbasins. Subbasin F1 in the north represents the area which contributes flows to the Eastern Drainage. Subbasin F2 in the south represents the area from which runoff occurs directly to Dexter Lake.

Subbasin F1

Subbasin F1 encompasses the northerly 18.6 acres of the above described Basin F. Within this subbasin, land use includes 12.4 acres of Single Family Residential (R1), 3.0 acres of General Commercial (C1), 2.8 acres of Public Lands (PL), and 0.4 acre of Multi-Family Residential (R3). This subbasin is almost fully developed with the exception of three vacant commercial lots adjacent to the intersection of Pioneer Street and Pengra Road.

Stormwater runoff generated east of Hyland Drive is diverted into a drainage ditch system which flows south to Pengra Road. Runoff from areas west of Hyland Drive flows overland into a ditch system on Pengra Road. These two drainage systems merge at the northeast corner of Hyland Drive and Pengra Road before discharging into the Eastern Drainage. There is also a storm drain along Main Street east of Pioneer Street that collects runoff from the southern portion of Subbasin F1 and discharges into the Eastern Drainage near the intersection of Main Street and West Boundary Road.

Subbasin F2

Subbasin F2 encompasses the southerly 13.2 acres of Basin F bordering Dexter Lake. The area includes 5.1 acres of Single Family Residential (R1) and 8.1 acres of Public Lands (PL). The portions of the subbasin that are zoned residential are developed. However, the only development besides roadways in the public lands zone is the City's water treatment plant, located on Parker Lane adjacent to Dexter Lake. The undeveloped areas in the public lands are heavily vegetated. Contour information indicates these areas are substantially inclined, sloping southeast toward Dexter Lake.

There is no storm drainage infrastructure in this subbasin. Stormwater runoff flows directly into Dexter Lake.

4.3.7 Basin G

Basin G encompasses a total of 64.7 acres on the peninsula bounded by Pengra Road on the north and by Dexter Lake on the south. The easterly boundary of Basin G is formed by Pioneer Street. Land use in Basin G includes single and multi-family residential, downtown commercial and public lands. Lundy Elementary, Lowell High School, Hyland Cemetery, and the City of Lowell wastewater treatment plant are all located within this basin.

Ground surfaces within Basin G slope gently to the west and south except within about 400 feet of the lake shore where grades become steeper. Runoff in Basin G generally occurs as overland flow or within roadside ditches along the shortest of several routes ultimately discharging into Dexter Lake. Storm drain piping is present beginning at Loftus Avenue and Everly Street and extending westerly between residences to the lake. Catch basins located on Alder Street approximately 300 feet south of Pengra Road also connect to this storm drain.

Soils in Basin G include Courtney gravelly silty clay loam (34), Pengra silt loam (105A), and Salkum silty clay loam (121B & C). These soils have slow to very slow permeability rates.

For modeling purposes, Basin G has been divided into four subbasins which represent the contributing areas to each of the four separate drainage paths identified. The subbasins are as described below.

Subbasin G1

Subbasin G1 encompasses 13.9 between Alder and Moss Streets south of Pengra Road. The southerly boundary is generally along West Main Street, although a portion of the Lundy Elementary School campus and a residence located on the southwest corner of Moss and Main Streets are included within Subbasin G1.

Over 90% of Subbasin G1 is zoned Single Family Residential (R1) and fully developed. The remaining areas are zoned Public Lands (PL) and include approximately one acre designated for the Hyland Cemetery, areas along the shore of Dexter Lake, and the northerly portion of Lundy Elementary School campus.

Stormwater runoff generated south of Loftus Avenue and west of Everly Street flows into a drainage ditch on W. Main Street that continues north on Alder Street. The Loftus/Everly storm drain system collects the remaining runoff and conveys the stormwater west where it merges with the Main/Alder ditch system. The combined stormwater discharges into Dexter Lake through an outfall located approximately 400 feet south of Pengra Road. Runoff generated west of Alder Street flows west directly into Dexter Lake.

Subbasin G2

Subbasin G2 encompasses 16.8 acres from Moss Street east to Pioneer Streets and from Pengra Road south to Lakeview Street. Ground surfaces within this subbasin are relatively flat. Runoff generally flows to the west and is collected in a storm drain system on Moss Street at which point the runoff flows south and discharges into Dexter Lake via an outfall located on the south end of Moss Street near the treatment plant.

Subbasin G2 contains all 5.8 acres of the City's Downtown Commercial (C2) district, which is only partially developed. The remainder of this subbasin is zoned Public Lands (PL) and includes the Lowell High School. A large sports field is present on the westerly portion of the school campus.

Subbasin G3

Subbasin G3 encompasses 25.8 acres primarily to the west of Moss Street and south of West Main Street. Ground surfaces within this subbasin generally slope to the south and west ranging from about 2% to 20% slope. Runoff generated in Subbasin G3 occurs overland by a variety of routes discharging directly into Dexter Lake.

Land use within Subbasin G3 includes 13.4 acres zoned Single Family Residential (R1), 0.8 acre zoned Multi-Family Residential (R3), and 11.6 acres zoned Public Lands (PL). Areas zoned Public Lands include Lundy Elementary School, vacant land along the lake shore, and a portion of the City of Lowell Wastewater Treatment Plant. The residential lands within this subbasin are almost fully developed.

Subbasin G4

Subbasin G4 lies in the southeastern corner of Basin G adjacent to Dexter Lake, Pioneer Street, and Lakeview Avenue. Its western boundary divides the wastewater treatment plant property. Zoning includes 1.4 acres of Public Lands (PL) and 6.9 acres of Single Family Residential (R1). Runoff occurs overland directly into Dexter Lake.

4.4 Existing Storm Drain System Inventory

The existing storm drainage system owned by the City of Lowell includes approximately 3.5 miles of pipe ranging in size from 8-inches to 48-inches diameter, as well as numerous storm drain manholes and catch basins/area drains. Table 4-1 provides an inventory of existing manholes and catch basins within the study area.

Table 4-1 provides an inventory of existing storm drain pipes. For the purposes of this inventory no effort has been made to distinguish between continuous storm drain pipes and culverts.

Table 4-1: Storm Drain Manhole and Catch Basin Inventory

Basin	Manholes	Catch Basins	Sediment Basins
A	0	4	
B	0	0	
C	0	2	
D	5	29	1
E	16	22	
F	4	21	
G	7	16	
Total	32	94	1

Table 4-2: Storm Drain Pipe Inventory

Basin	Storm Drain Pipe Diameter (inches)										Total
	8	10	12	18	24	30	32	36	48	Unknown	
A		137		113	178					15	443
B			216								216
C		52	380	87	287			54		51	911
D	68	1214	2530	248	252	302	406	60	441	490	5943
E			2310	676	543	114				1042	4685
F		48	898	515				66		287	1814
G		93	1742	989				1328		109	4261
Total	68	1544	8076	2628	1260	416	406	1508	441	1994	18273
Percentage	0.4%	8.4%	44.2%	14.4%	6.9%	2.3%	2.2%	8.3%	2.4%	10.9%	100%

All lengths are in feet

The storm drainage system inventory presented in the preceding tables was compiled based on "as-built" plans obtained from the City and from site investigations performed by HBH Consulting Engineers.

4.4.1 Storm Drain Outfalls

As described previously Lowell's storm drainage system includes a variety of pipes, culverts, open drainage ditches, and natural streams for conveyance of runoff. Due to this storm drain infrastructure mixture there are numerous outfalls where pipes discharge into creeks (Western, 6th Street, 4th Street, and Eastern drainages) or into Dexter Lake. An effort has been made to evaluate the condition of outfalls of the major storm drain pipes within the study area. A number of the outfalls are inaccessible due to terrain, vegetation, or location on or behind private property. Outfalls have been numbered using the letter of the basin in which they occur followed by a number. Table 4-3 provides a summary of the location, size and condition of the various storm drain outfalls within the study area.

Outfall D1

Outfall D1 consists of consists of two 60-inch concrete pipes that discharges flow from the 4th street drainage into a drainage swale directly west of Moss Street at 4th street. The pipe is connected to storm drain system along 4th Street that conveys flow for most of basin D1. The culverts are estimated to lie at a slope of 2% or less and have an estimated combined capacity in excess of 400 cfs. The pipes appear to be in good shape and are expected to have adequate capacity for buildout flows generated within Subbasin D1. Vegetation within the channel downstream of the pipes should be cleaned out periodically to maintain capacity of the system.



Outfall D2

Outfall D2 is believed to consist of a pair of 12" diameter pipes that cross under Moss Street at the intersection of 3rd Street. Field staff was unable to gain access to the pipes as they are believed to discharge into an overgrown swale located on private property. The pipes are part of the storm drainage system located on the east side of Moss Street from Pengra Road to the park located on 3rd Street. Condition of the pipes is uncertain.



Outfall F1

Outfall F1 consists of an 18-inch concrete pipe that discharges into the Eastern Drainage at the east end of E. Main Street just south of the intersection of Pengra Road and Hyland Drive. The pipe is connected to storm drain system which includes six catch basins that collect runoff at the intersection of Main Street and Pengra Road. This was constructed in the early 90's and is still in good condition.

Outfall F2

Outfall F2 is located approximately 120 feet east of Pioneer Street on the south end of the City and consists of a 12-inch diameter HDPE pipe. The pipe is connected to two catch basins and discharges directly into Dexter Lake. As-built plans provided by Lane County indicate the outfall has rip rap protection to prevent erosion, but no water quality element. This was constructed in the summer of 2005 and is still in like new condition.

***Outfall G1***

Outfall G1 discharges into Dexter Lake and is located approximately 100 feet west of Alder Street and 500 feet south of Pengra Road. The pipe is connected to the Loftus Avenue and Alder Street drainage system. The outfall is located on private property and was not visible from the street. It is known to be an 18" concrete pipe, however condition is uncertain.



Outfall G2

Outfall G2 consists of a 36-inch concrete pipe located at the south end of Moss Street which discharges into Dexter Lake. The outfall is submerged so it could not be visually inspected and its condition is unknown.



Table 4-3: Storm Drain Outfall Summary

Map #	Location	Size (in)	Material	Full-Flow Capacity (cfs)	Condition
D1	Under Moss Street at the intersection of 4 th Street	(2) 60"	Conc.	309*	Excellent
D2	Under Moss Street at the intersection of 3 rd Street	Unknown	Unknown	Unknown	Unknown
F1	East end of E. Main Street, just south of the intersection of Pengra Road and Hyland Drive	18"	Conc.	16**	Good
F2	South end of the City, 120 feet east of Pioneer Street	12"	HDPE	10	New
G1	100 feet west of Alder Street and 500 feet south of Pengra Road	18"	Conc.	16**	Unknown
G2	South end of Moss Street	36"	Conc.	72*	Unknown

* Based on 1% pipe slope
 ** Based on 2% pipe slope

4.4.2 Culverts

There are numerous culverts within the study area at points where roadways cross streams and open drainage channels. This subsection presents an overview of the location and condition of the major culverts within the study area. The culverts are numbered by basin in the following format: A3-C, where A is the basin designation, 3 is the culvert number, and C is included to differentiate culverts from storm drain outfalls. Descriptions of the location and apparent condition of the culverts are presented on the following pages. A summary of the culverts is presented in Table 4-4.

Culvert A1-C

Culvert A1-C includes a single 18-inch corrugated metal pipe across Moss Street approximately 130 feet north of Seneca Street. The culvert is estimated to lie at a slope of 2% or less and has no inlet/outlet structures. The pipe's maximum capacity is 8.7 cfs based on 2% slope and appears to be undersized for larger storm events; however there are no reports of any flooding in the area. The pipe is beginning to show signs of flaking and has damage to its inlet end. When the culvert is replaced, a minimum 24-inch diameter concrete or plastic pipe at a slope of at least 2% should be used.



Culvert B1-C

Culvert B1-C, also known as the "Love Canal", consists of a single 72-inch by 48-inch concreted box culvert located at the crossing of Pengra Road and 2nd Street. It is estimated that the culvert lies at a slope of 2% or less and has a maximum capacity in excess of 400 cfs based on 2% slope. It appears to be in good condition, but was difficult to get close to due to overgrown vegetation and proximity to the lake. Capacity of this culvert is considered adequate based on the calculated future peak flows.



Culvert C1-C

Culvert C1-C consists of a single 36-inch corrugated metal pipe located at Moss Street and 6th Street. The culvert is estimated to lie at a slope of 2% or less. The maximum capacity of a 36-inch CMP culvert at 2% slope is 55.1 cfs. The pipe appears to be in relatively good condition with adequate capacity for current conditions. However, the culvert is undersized for 20-year and buildout conditions and should be cleared of debris at the inlet and outlet to improve current performance. When the culvert is replaced, a minimum 36-inch diameter concrete or plastic pipe at 2% slope should be provided.



Culvert C2-C

Culvert C2-C includes two 24" HDPE pipes located west of the crossing of Moss Street and 6th Street that combine flows from the west Moss Street ditch and 6th Street Drainage and convey the water under a foot path prior to discharging into the Western Drainage. These pipes are relatively new and in good shape. Combined they have an estimated maximum capacity of 68.8 cfs based on 2% slope, which is adequate for the calculated buildout flows.



Culvert C3-C

Culvert C3-C is a single 24" CMP pipe which crosses Moss Street at the intersection of 7th Street. The pipe carries flow from the northwestern corner of the basin and discharges to the west side of Moss Street. This pipe is in good shape and has a maximum capacity of 18.6 cfs based on 2% slope. Both the inlet and outlet were overgrown with briars and other vegetation and there were reports that during large events flow from this pipe discharged out of the roadside ditch and onto neighboring properties.



Culvert D1-C

Culvert D1-C consists of five 24-inch concrete pipes which cross a private road located approximately 120 feet west of Moss Street north of 4th Street. The pipes have bar screened inlets to prevent entry of large objects. Stormwater enters the Western Drainage approximately 120 to the west. The slope of the pipes is estimated at 2% or less. The maximum capacity of each pipe is estimated at 34.4 cfs, based on a 2% slope, for a total capacity of 172 cfs. These pipes appeared to be in reasonably good condition.



Culvert D2-C

Culvert D2-C includes two 24-inch corrugated metal pipes which cross Damon Street approximately 330 feet north of 2nd Street. The subject drainage swale discharges into the Western Drainage approximately 120 feet to the west. The culverts are estimated to lie at a slope of 3% or less and have no type of inlet or outlet structures. The pipes have a maximum capacity of 22.8 cfs each based on 3% slope, or a combined capacity of 45.6 cfs. The pipes appear to be in relatively good condition, although some corrosion is evident. Pipe capacity is adequate to convey the calculated buildout flows.



Culvert D3-C

Culvert D3-C includes two 30-inch corrugated metal pipes located along the Western Drainage at the crossing of a private road between 4th and 6th Streets. The culverts are estimated to lie at a slope of 2% or less and have no type of inlet or outlet structures. The maximum capacity of each pipe is 33.9 cfs based on 2% slope, for a combined capacity of 67.8 cfs. Debris should be cleared from the inlet of the culverts to ensure the maximum capacity is actually available. These pipes are undersized for the calculated peak flows at this point in the Western Drainage based on the 25-year storm. It is recommended that the pipes be replaced with 30-inch or larger HDPE pipes at a slope of 2% or greater in order to pass the calculated peak stream flows.



Culvert D4-C

Culvert D4-C includes two 36-inch corrugated metal pipes located west of Damon Street near the intersection of 3rd Street. These pipes are along the Western Drainage at the crossing of a private driveway. The pipes are estimated to lie at a slope of 2% or less and have no type of inlet or outlet structures. Visual inspection showed these pipes to be in good condition. The maximum capacity of each pipe is 55.1 cfs based on 2% slope. These pipes are undersized for the calculated peak flow within the Western Drainage at this point. A minimum of two 36-inch diameter HDPE culvert pipes at a slope of 2.2 % or greater is recommended to provide adequate capacity for calculated future peak flows.



Culvert E1-C

Culvert E1-C consists of a single 36-inch by 48-inch concrete box culvert with a concrete headwall located approximately 150 feet east of Hyland Drive. The flows from the Hyland Drive and Pengra Road converge with the Eastern Drainage immediately upstream of E1-C which passes the combined flow under an unnamed road north of West Boundary Road. The culvert is estimated to lie at a slope of 2% or less. It has an estimated capacity in excess of 180 cfs at 2% slope. Visual inspection indicated the concrete was still in good condition on the inlet end, however the discharge side was very overgrown and visual inspection was not possible. The culvert has adequate capacity for calculated future flows.



Culvert E2-C

Culvert E2-C consists of parallel 36-inch and 42-inch concrete pipes which cross West Boundary Road just east of Parker Lane. The pipes are estimated to lie at a slope of 2% or less and have a combined maximum capacity of 267 cfs based on 2% slope. Both pipes are in good condition and together they have adequate capacity for the calculated present and future peak flows within the Eastern Drainage.



Culvert E3-C

Culvert E3-C consists of a single 30-inch pipe under east 1st Street. The upstream end of the pipe is corrugated metal and the outlet is PVC. The material change likely occurs under the southern sidewalk where the pipe is believed to be combined with a storm drain pipe along 1st Street. The pipe discharges between two existing residences. The upstream end of the pipe is partially blocked with rock limiting its hydraulic capacity; it is estimated at less than 20 cfs. The downstream end of the pipe is in good condition and would allow for a greater hydraulic capacity, which is necessary since it handles not only the inlet flow, but that from the storm pipe along 1st Street. The calculated maximum discharge capacity of this pipe is 73.9 cfs based on 2% slope. However, it is partially submerged and a more detailed analysis would need to be done to take into account the backwater effect. This pipe is undersized for the calculated peak flow at this point based on the 25-year storm. A minimum 30-inch HDPE or PVC pipe at a slope of at least 2% is recommended to provide adequate capacity for calculated future peak flows.



Culvert F1-C

Culvert F1-C consists of a single 18-inch concrete pipe that collects stormwater in a small depression located at the intersection of Pengra Road and Hyland Drive. It conveys runoff under Hyland Drive towards the Eastern Drainage. The pipe is half buried with sediment and rock and the end has some damage. With the pipe being partially plugged its hydraulic capacity is significantly limited. The estimated present hydraulic capacity is less than 5 cfs based on 2% slope. When clean the capacity would be 16.0 cfs based on 2% slope. The pipe is considered adequately sized to convey present and future flows from the contributing area provided it is kept clean. If the sediment cannot be removed, the pipe should be replaced with a minimum 18-inch concrete or plastic culvert.



Culvert F2-C

Culvert F2-C includes a single 12-inch concrete pipe located on the south side of the intersection of East Main Street and Pengra Road which conveys water into the Eastern Drainage. This was constructed in the early 1990's and is still in good condition. The maximum hydraulic capacity of this pipe is estimated at 5.4 cfs based on 2% slope. Its present capacity is reduced due to sediment in the invert.



Table 4-4: Culvert Summary

Map #	Location	Size (in)	Material	Maximum Capacity (cfs)	Condition
A1-C	Moss Street, 130 feet north of Seneca Street	18	CMP	8.7	Poor
B1-C	Pengra Road and 2 nd Street.	48 x 72	Conc.	400+	Good
C1-C	Moss Street and 6 th Street	36	CMP	55.1	Good
C2-C	Moss Street and 6 th Street, west of C1-C	2 @ 24	HDPE	68.8	Good
C3-C	Moss Street at 7 th Street	24	CMP	18.6	Good
D1-C	Private Road, 115 feet west of D1-C	5 @ 24	Conc	172	Good
D2-C	Damon Street, near 3 rd Street	2 @ 24	CMP	45.6	Good
D3-C	Western Drainage near 5 th Street	2 @ 30	CMP	67.8	Good
D4-C	Western Drainage near Damon Street	2 @ 36	CMP	110.2	Good
E1-C	Unnamed road, 150 feet east of Hyland Road	36 x 48	Conc.	180+	Good
E2-C	North end of Parker Lane	36 & 42	Conc.	267	Good
E3-C	1 st Street east of Hyland	30	Mixed	20+/-	Poor
F1-C	South end of Hyland Drive	18	Conc.	5+/-	Poor
F2-C	E. Main Street and Pengra Road	12	Conc.	5.4	Good

Stormwater Master Plan
Chapter 5



5.0 Hydrologic Analysis

This chapter presents the basis of the hydrologic analysis used in evaluating the City's existing storm drainage facilities within this master plan. There are several classifications of hydrologic models used for stormwater runoff analysis, each with a specific application to which it is best suited. The classifications include calibrated and uncalibrated peak discharge models, single event hydrograph models, watershed multiple event models, and joint probability models. Each of these types of models and their specific applications is discussed in depth in the textbook, "Hydrologic Analysis and Design," by Richard H. McCuen, Prentice-Hall, Inc., 1989. For the purposes of this master plan an uncalibrated peak discharge model has been used. A calibrated model would require peak discharge data obtained from flood frequency analyses at gauged sites. We are not aware of any studies within the City of Lowell to provide such data.

The peak discharge is a primary variable for the design of stormwater runoff pipe systems, storm inlets, culverts, and small open channels. It also can be used for hydrologic planning such as small detention facilities. Peak discharge modeling is considered an acceptable method for designs where the time variation of storage is not a primary factor in the runoff process. Storm drainage basins identified in the preparation of this master plan range in area from about 32 acres to 234 acres. For basins of this range of sizes and accounting for the fairly short drainage routes within the study area, significant storage is not expected to occur. Therefore, peak discharge modeling is considered appropriate for design of storm drainage facilities within the City of Lowell. Even in basins where some storage is likely to occur, peak discharge modeling is acceptable as it would tend to result in facilities being conservatively oversized rather than undersized.

5.1 *Rational Method*

McCuen notes that several peak discharge hydrologic models exist for various applications based on land use, terrain, and characteristics of the primary drainage route. The Rational Method is the most widely used equation. Mathematically, the Rational Method relates the peak discharge (q_p , ft³/sec) to the drainage area (A , acres), the rainfall intensity (i , in/hr), and the runoff coefficient (C) by the following formula:

$$q_p = CiA$$

The rainfall intensity is obtained from an intensity-duration-frequency (IDF) curve using the return period and a duration equal to the time of concentration (T_c) as input. The value of the runoff coefficient is a function of the land use, cover condition, soil group, and surface slope.

A primary use of the Rational Method has been for design of storm drainage systems for small urban areas (less than 200 acres) which are characterized by small drainage areas, short times of concentration and relatively uniform land use. For such designs, short duration storms are critical, which is why the time of concentration is used as the input duration for obtaining i from the IDF curves.

5.2 SCS Rainfall Runoff Relationship

The Soil Conservation Service (SCS; now NRCS) has developed a method for relating rainfall to runoff which considers an entire watershed with a variety of land uses and soil types. The method, described in length in Technical Release 20 (TR-20) published by the SCS, is based upon unit hydrograph theory and the runoff curve number method of calculating direct runoff from the rainfall occurring over specified areas. The TR-20 method also allows watershed areas (basins) to be divided into subbasins for analysis purposes, with drainage routes of one or more subbasins running through other subbasins downstream. This provides for the calculation of an overall peak discharge from a basin that may or may not equal the sum of the peak discharges from the individual subbasins. The TR-20 method is considered much more versatile for modeling complex areas where the Rational Method is limited.

The volume of storm runoff depends on a number of factors, including but not limited to, rainfall volume. For very large watersheds, the volume of runoff from one storm event may depend on rainfall that occurred during previous storm events. However, for smaller watersheds such as those identified within this master plan, hydrologists usually assume that runoff from a given storm event is independent of rainfall which occurred in previous events. This assumption of storm independence is common and has been applied herein.

5.2.1 Factors Affecting Runoff Volume

In addition to rainfall, other factors affecting the volume of runoff include land cover, land use, soil type, and antecedent soil moisture conditions. In hydrologic modeling, the amount of rainfall available for runoff is typically separated into three parts: direct runoff, initial abstraction, and losses. Land cover and use, soil type and antecedent soil moisture conditions affect the split between losses and runoff. Many factors affect the separation of rainfall into direct runoff and losses, and therefore hydrologic modeling requires that a number of assumptions be made in order to simplify the process.

5.2.2 SCS Rainfall – Runoff Equation

Development of the SCS rainfall – runoff relationship included dividing the total rainfall (P) into the following components: direct runoff (Q), actual retention (F), and the initial abstraction (I_a). The initial abstraction is the amount of rainfall at the beginning of a storm that is not available for runoff. It includes water retained in surface depressions, water intercepted by vegetation, evaporation, and infiltration. The actual retention is the difference between the amount of rainfall available for runoff and the actual runoff. It is quantified according to the following relationship:

$$F = (P - I_a) - Q$$

The potential maximum retention (S) is assumed to have the following relationship to the other components:

$$F / S = Q / (P - I_a)$$

By substituting the first equation above into the second and by rearranging to isolate Q , the following relationship is derived:

$$Q = (P - I_a)^2 / [(P - I_a) + S]$$

The preceding equation contains one known value, P , and two unknown variables, I_a and S which must be estimated in order to calculate the runoff volume. According to the NRCS Technical Release 55 (TR-55) I_a is highly variable but generally is correlated with soil and cover parameters. It is further noted in TR-55 that through studies of many small agricultural watersheds, I_a was found to be approximated by the following empirical equation:

$$I_a = 0.2S$$

By substituting the above equation for I_a in the previous runoff equation, the following equation, having only a single unknown, S , is derived after simplifying:

$$Q = (P - 0.2S)^2 / (P + 0.8S)$$

The preceding equation is identified as the basic equation for computing the runoff depth, Q , for a given rainfall depth, P . In this expression Q and P have units of depth (inches) but are commonly referred to as volumes as it is assumed for design that rainfall occurs at a uniform depth over the entire watershed.

5.2.3 Runoff Curve Numbers

In order to compute the runoff for a given depth of precipitation within a watershed one must be able to estimate the retention, S . The SCS runoff curve number (CN) was developed for this purpose. The curve number is an index that represents the combination of a hydrologic soil group and a land use and treatment class. Curve numbers are indicated to be functions of the three factors, soil group, cover complex, and antecedent moisture conditions. The CN has a range of 0 to 100 and is related to S according to the following equation:

$$S = (1000/CN) - 10$$

Soil Group Classification

The SCS method includes dividing soils into four groups represented by the letters A, B, C, and D. Group A soils are identified as deep sand, deep loess, and aggregated silts and are defined as having a minimum infiltration rate of 0.30 to 0.45 inch/hour. Group B soils include shallow loess and sandy loam with infiltration rates ranging from 0.15 to 0.30 inch/hour. Group C soils are those low in organic content and usually high in clay, including clay loams and shallow sandy loams with an infiltration rate in the range of 0.05 to 0.15 inch/hour. Group D soils are those that swell significantly when wet including fat (highly plastic) clays and certain saline soils and are identified as having an infiltration rate less than 0.05 inch/hour.

The NRCS Soil Survey for Lane County identifies a variety of different soil types within the study area. Figure 3-5 shows the location of each soil type and gives a brief description of characteristics, including a rate of permeability ranging from very rapid to very slow. For modeling purposes, soil types identified by the Soil Survey as having moderately rapid to moderate permeability were classified as Group B soils; soil types identified as having moderately slow permeability were classified as Group C soils; and soil types identified as having slow to very slow permeability were classified as Group D soils. None of the soil types identified within the study area were indicated to have very rapid to rapid permeability and consequently no Group A soils were considered in the stormwater modeling performed herein.

Cover Complex Classification

The cover complex classification developed by SCS consists of three factors: land use, treatment or practice, and hydrologic condition. There are approximately 21 different land uses identified in the tables for estimating curve numbers. In reviewing cover complex within watershed areas for analysis of specific storm drains, land uses were generally found to be of one of the following classifications: open space (lawns, parks, etc.), paved streets with curbs, paved streets with open ditches, gravel roads, residential districts with 1/8 acre to 2 acre average lot sizes, commercial/business districts, industrial, and undeveloped forest or brush areas.

Curve Number Selection

Curve numbers used in the stormwater modeling performed for this study were determined from the runoff curve number table (Table 2-2) contained within TR-55 as published by the NRCS. A copy of the table is contained within Appendix B. The CN for each distinct area identified within the watersheds was selected based on a combination of the cover complex and hydrologic soil group of the specific location as explained above. The land area applying to each CN identified was determined from the City's aerial topographic mapping and the Soil Map (Figure 3-5). An overall weighted CN was calculated for each watershed area based on the individual CN's and their corresponding land areas. Peak runoff was calculated using the weighted CN for each watershed area analyzed. The following table presents curve numbers that were selected representing a variety of land uses identified within the study area.

Table 5-1 – SCS Curve Numbers for Identified Land Uses

Cover Type and Hydrologic Condition	Hydrologic Soil Group		
	B	C	D
Open Space (lawns, parks, cemeteries, etc.) – good condition	61	74	80
Open Space (lawns, parks, cemeteries, etc.) – fair condition	69	79	84
Paved Streets w/ curbs and storm drains	98	98	98
Paved Streets w/ open ditches	89	92	93
Commercial and business districts	92	94	95
Industrial areas	88	91	93
Residential with 1/8 acre or smaller lots, town houses	85	90	92
Residential with 1/4 acre lots	75	83	87
Residential with 1/3 acre lots	72	81	86
Residential with 1/2 acre lots	70	80	85
Residential with 1 acre lots	68	79	84
Residential with 2 acre lots	65	77	82
Woods (Forestland) – Grass combination – fair condition	65	76	82
Woods (Forestland) – Grass combination – good condition	58	72	79
Brush – brush-weed-grass mixture – poor condition	67	77	83
Brush – brush-weed-grass mixture – good condition	48	65	73

5.2.4 Time of Concentration

The time of concentration (T_c) is an important input parameter used in runoff calculations. There are two commonly accepted definitions of the time of concentration. In the first, T_c is defined as the length of time for a particle of water to travel from the most distant point in a watershed to the point of design (i.e. outlet). The second definition is based on a rainfall hyetograph and the resulting runoff hydrograph. A hyetograph is the curve obtained when rainfall depth is plotted against time for a measured storm event. A hydrograph is a plot of runoff versus time for a watershed area. In the second definition of time of concentration, T_c is the time between the center of mass of rainfall excess and the inflection point on the

recession of the direct runoff hydrograph. Both the rainfall excess and direct runoff are computed from the actual hyetograph and hydrograph. No direct rainfall or runoff data exist for the storm drainage basins identified herein and therefore attempting to compute the rainfall excess and direct runoff from any given basin is impractical.

Times of concentration for each basin have been calculated using velocity methods to determine the time for runoff to travel from the most distant point of the basin to the outlet. According to common practice, T_c has been computed as the sum of the individual travel times for each component of the drainage conveyance system. Runoff velocity for each component is determined based on surface roughness, channel shape, and slope. Runoff moves through a watershed as sheet flow, shallow concentrated flow, open channel flow, or some combination of these. The travel time (T_i) for an individual segment of the drainage system is equal to the length (L) of the segment divided by the velocity (V) of runoff within that segment, as shown below:

$$T_i = L/V$$

The velocity of overland flow has been estimated using the following relationship between velocity (ft/sec) and slope (percent):

$$V = kS^{0.5}$$

The value of k from the above equation is a function of land cover and has been determined according to the following table:

Table 5-2 – Land Cover Coefficients

K	Land Use / Flow Regime
0.25	Forest with heavy ground litter; hay meadow (overland flow)
0.50	Trash fallow or minimum tillage cultivation; contour or strip cropped; woodland (overland flow)
0.70	Short grass pasture (overland flow)
0.90	Cultivated straight row (overland flow)
1.00	Nearly bare and untilled (overland flow); alluvial fans in western mountain regions
1.50	Grassed waterway
2.00	Paved area (sheet flow); small upland gullies

Flow velocities within pipes and open channels have been computed using Manning's equation:

$$V = (1.49/n)R_h^{2/3}S^{0.5}$$

where V is the velocity (ft/sec), n is the roughness coefficient, R_h is the hydraulic radius (feet), and S is the slope (ft/ft). The hydraulic radius R_h is defined as the area of the flow cross section divided by its wetted perimeter. For simplicity sake, velocities in pipes have been calculated based on full flow conditions. For full or half-full pipes, the formula for hydraulic radius R_h is simplified as follows:

$$R_h = d_o/4$$

where d_o is the inside diameter of the pipe. For pipe flow conditions other than full or half-full, the formula for determining hydraulic radius is more complex.

The roughness coefficient n used in Manning's equation is a function of the channel or pipe material and condition. Studies have determined Manning's n for a number of different channel/pipe materials. The

following table provides some typical values. The tabulated values are excerpted from Table 5, Chapter 10 of the textbook "Elementary Fluid Mechanics"; Seventh Edition; Robert L. Street, Gary Z. Watters, and John K. Vennard; Copyright 1996; John Wiley & Sons, Inc.

Table 5-3 – Manning's n for Partially Full Pipes and Open Channels

Type of Conduit	Minimum n	Normal n	Maximum n
Corrugated Metal	0.021	0.024	0.030
Cement Mortar Lined (neat)	0.010	0.011	0.013
Concrete Culvert (finished)	0.011	0.012	0.014
Earth Channel, straight and uniform, clean	0.016	0.018	0.020
Earth Channel, straight and uniform, short vegetation	0.022	0.027	0.033
Earth Channel, winding, clean	0.023	0.025	0.030
Earth Channel, winding, short vegetation	0.025	0.030	0.033
Natural Channel, straight, no riffles or pools	0.025	0.030	0.033
Natural Channel, winding, some pools and shoals	0.033	0.040	0.045

In addition to the above tabulated values, information provided by manufacturers of plastic pipe products indicate that Manning's n values in the range of 0.009 to 0.011 typically apply for PVC pipe with smooth inner walls and Manning's n values in the range of 0.009 to 0.015 apply for corrugated HDPE pipe with smooth inner walls. For the purposes of this master plan, we have used a Manning's n value of 0.011 for all PVC and HDPE culvert pipe with smooth inner walls. We are not aware of any HDPE culvert pipe within the study area that has corrugated inner walls.

5.2.5 Rainfall

Rainfall is the driving force of hydrologic design. Problems result when rainfall occurs at extreme volumes or rates. High rates of rainfall on small urban watersheds cause flooding of streets and parking lots because the drainage facilities were not designed to drain all the water generated by high rainfall rates. Some hydrologic planning and design requires only a volume of rainfall. For the purposes of hydrologic analysis and design, however, the distribution of rainfall with respect to time is usually required. The time distribution of rainfall is called a hyetograph. A hyetograph is a graph of the rainfall intensity or volume as a function of time.

Storm events can be separated into two groups, actual storms and design storms. Rainfall analysis is based on actual storms. Hydrologic designs are typically based on what is called the design storm approach. A design storm is a rainfall hyetograph with predefined characteristics, not an actual measured storm event. In fact, a real storm identical to the design storm most likely has not occurred and will not ever occur. Design storms have characteristics that are the average of the characteristics of storms that occurred in the past and therefore represent the average characteristics of storm events that are expected to occur in the future.

The three most important storm characteristics in hydrologic analysis and design are duration, volume, and frequency. The volume of a storm is often reported as a depth (i.e. inches). The depth is assumed to occur uniformly over an entire watershed. Therefore, the volume is actually the product of the depth times the area of the watershed. Another closely related characteristic is the intensity which is equal to the volume divided by the duration. A specified volume of rainfall may result from many different combinations of intensities and durations. The intensity and duration of a storm will have a significant effect on the resulting rate and volume of runoff.

Just as intensity, duration and volume are important in storm drainage system design, frequency also is a necessary determinant. Frequency can be discussed as either the exceedence probability or the return period. The exceedence probability is the probability that a storm of specified volume and duration will be exceeded in any one year. The return period is the average length of time between events of a specified volume and duration. The exceedence probability is inversely proportional to the return period. For example, if a storm of a specified duration and volume has a 1% chance of occurring in any one year, it has an exceedence probability of 0.01 and a return period of 100 years.

The relationship between volume (or intensity), duration and frequency is location dependent. That is, a storm with a given volume and duration will occur at a different frequency in one location than another. Because of the importance of the relationship between volume (or intensity), duration and frequency in hydrologic design, studies have been performed to develop rainfall volume – duration – frequency (VDF) curves and intensity-duration-frequency (IDF) curves for most localities. Lowell is identified as lying within Oregon's IDF Zone 5.

Constant Intensity Storm

Frequently hydrologic designs on very small urban watersheds are designed based on constant intensity storms. The critical cause of flooding is often short-duration, high-intensity rainfall. Therefore, it is assumed that for the critical storm duration, the rainfall intensity will be constant. It is intuitive that the largest peak runoff rate occurs when the entire drainage area is contributing, and so it is common to assume that the duration of the design storm equals the time of concentration of the watershed. The intensity of the storm is obtained from an IDF curve for the location, often using the time of concentration as the duration and the frequency specified by the design standards (i.e. 10-year, 25-year, etc.) For a constant intensity storm, the rainfall volume is equal to the intensity multiplied by the duration.

SCS 24-Hour Storm Distributions

The SCS developed four dimensionless rainfall distributions using the Weather Bureau's Rainfall Frequency Atlases. The rainfall frequency data for areas less than 400 mi², for durations to 24 hours and for frequencies from 1 to 100 years were used. Analysis indicated four major regions, and the resulting rainfall distributions were labeled type I, IA, II, and III. The locations where these design storms should be used are shown in Figure 5-1. As indicated, Type IA design storms should be used for Lowell.

Figure 5-1 – Geographic Areas for SCS Rainfall Distributions

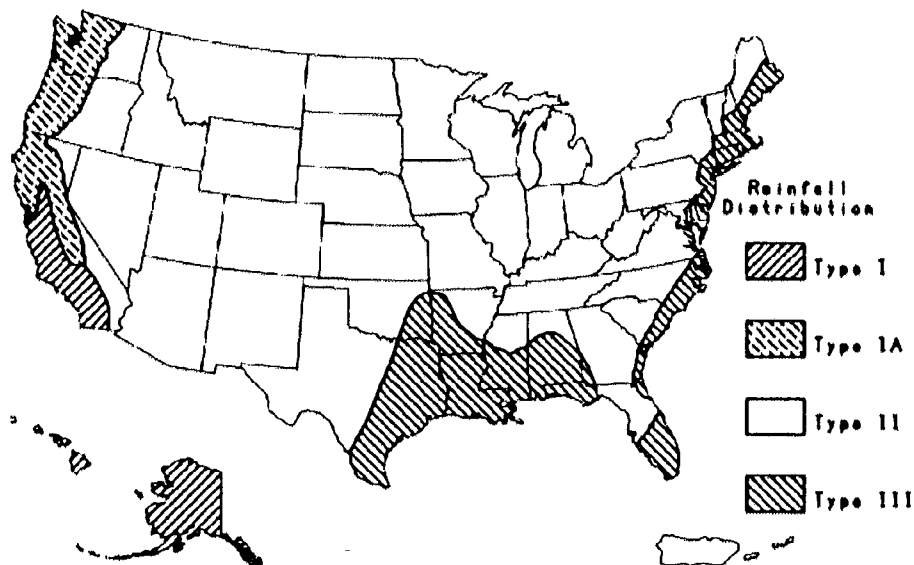

Rainfall Distribution

The SCS rainfall distributions are based on generalized rainfall volume-duration-frequency relationships obtained from Weather Bureau technical publications. Rainfall depths for various durations were used to derive the storm distributions. Incremental rainfall depths were determined using 6-minute increments. The time of the peak rainfall was found from the analysis of measured storm events to be location dependent. For the regions with type I and IA storms, the peak intensity was found to occur about 8 hours after the beginning of the storm, while for the regions with type II and III storms, the peak was found to occur at the center of the storm, about 12 hours. The SCS 24-hour rainfall distributions are graphically presented in Figure 5-2 below.

Figure 5-2 – SCS 24-Hour Rainfall Distributions

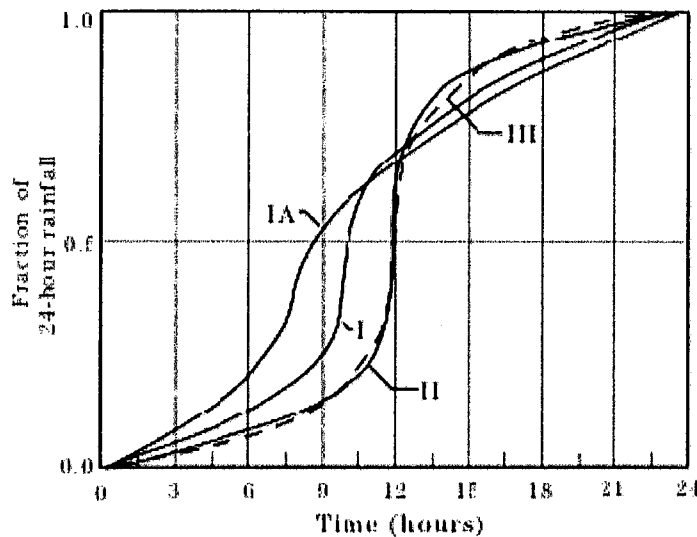

It is assumed for type II and III storms that the greatest 6-minute depth occurs at the middle of the 24-hour period, the second largest 6-minute incremental depth in the next 6 minutes, the third largest in the 6-minute interval preceding the maximum intensity, and so on, with each incremental rainfall depth to be of decreasing order of magnitude. The smallest increments fall at the beginning and end of the 24-hour storm. This procedure results in the maximum 6-minute depth is contained within the maximum 1-hour depth, the maximum 1-hour depth is contained within the maximum 6-hour depth, and so on. For type I and IA storms, the maximum incremental rainfall depth occurs at about 8-hours, with successively lower incremental depths following and preceding the maximum, and so on. Because all the critical storm depths are contained within the storm distributions, the distributions are appropriate for designs on both small and large watersheds. Type IA design storms have been used for each basin defined herein.

Rainfall Intensity

The IDF curves for an area can be used to obtain the rainfall intensities for storm durations of 5 minutes to 6 hours. A design storm can be formed using incremental data obtained from the IDF curves. This process can be somewhat cumbersome. Alternatively, isopluvial maps can be used to determine the total rainfall depth for a specific geographic area based on rainfall depth contours for storms of specific durations and return periods. For Oregon, maps are available for storms of 6-hour and 24-hour durations and 2, 5, 10, 25, 50, and 100-year return periods. Isopluvial maps for the Lowell vicinity are presented in Appendix C for the 24-hour duration storms. The total rainfall depths presented in the following table were obtained from the isopluvial maps.

Table 5-4 – Design Storm Rainfall Totals for Lowell

Design Storm Return Period	24-Hour Rainfall Total
2-year	3.5 inches
5-year	4.25 inches
25-year	5.0 inches
50-year	5.5 inches
100-year	6.0 inches

The Oregon Department of Transportation Hydraulics Manual recommends that storm drainage designs for city streets utilize a 25-year design storm, designs for state highways be based on a 50-year design storm, and other cases where roadway overtopping is likely a 100-year design storm be used. For the purposes of this master plan the 25 year design storm has been considered as there are no state highways within the study area and no likely areas of roadway overtopping.

5.2.6 Hydrographs and Discharge

As defined previously, a hydrograph is a plot of the runoff from a watershed over time. The variation in flows represented on a hydrograph for a watershed area is expected to correlate to the variation in the rainfall hyetograph. For this study, runoff hydrographs used for analysis of the existing facilities were calculated for each storm drainage basin based on the 25-year Type IA design storms using the SCS TR-20 method. In accordance with the proposal for this Master Plan, we have also calculated runoff hydrographs from the various basins for the 5-year and 100-year design storms. Calculations were performed using HydroCAD Version 5.11 modeling software which includes the SCS TR-20 method as one of the methods to calculate runoff. Results of the modeling are presented in Appendix A.

Stormwater Master Plan

Chapter 6



6.0 Storm Drain Model

The existing storm drainage systems within the study area has been modeled in order to determine the existing capacity of various system components for the existing and future stormwater discharges that are likely to occur from each basin and sub-basin modeled. A number of factors affect the analysis including but not limited to land use, soil type, and both surface condition and vegetation in undeveloped areas. Each storm drainage route identified in this section has been modeled based on the estimated area drained as determined from topographic mapping provided by LCOG (Lane Council of Governments). Ground surface slopes, existing development, and the presence of drainage facilities also is based on mapping provided by LCOG and field investigation completed by HBH Consulting Engineers. Potential future discharges have been calculated using information from the zoning and land use mapping provided by the City of Lowell.

As explained in the previous Chapter, we have used the SCS (TR-20) Method to calculate stormwater discharge from the identified basins and subbasins based on the 25-year design storm. The SCS Method utilizes curve numbers to rate the runoff potential of an area based on the land use, cover condition and soil type. The table below presents curve numbers for various land use classifications that were identified within the study area. Areas identified for future development were assigned curve numbers representative of the development expected to occur.

Table 6.1 – SCS Curve Numbers for Identified Land Uses

Cover Type and Hydrologic Condition	Hydrologic Soil Group		
	B	C	D
Open Space (lawns, parks, cemeteries, etc.) – good condition	61	74	80
Open Space (lawns, parks, cemeteries, etc.) – fair condition	69	79	84
Paved Streets w/ curbs and storm drains	98	98	98
Paved Streets w/ open ditches	89	92	93
Commercial and business districts	92	94	95
Industrial areas	88	91	93
Residential with 1/8 acre or smaller lots, town houses	85	90	92
Residential with 1/4 acre lots	75	83	87
Residential with 1/3 acre lots	72	81	86
Residential with 1/2 acre lots	70	80	85
Residential with 1 acre lots	68	79	84
Residential with 2 acre lots	65	77	82
Woods (Forestland) – Grass combination – fair condition	65	76	82
Woods (Forestland) – Grass combination – good condition	58	72	79
Brush – brush-weed-grass mixture – poor condition	67	77	83
Brush – brush-weed-grass mixture – good condition	48	65	73

6.1 Basin Descriptions

The following basin descriptions include summaries of current and future land use, soil type, range of ground surface slope based on the identified soil types, calculated peak runoff for existing and future development conditions, and existing storm drainage facilities. Some basins are largely undeveloped at this time. Estimates have been made regarding development that is likely to occur in order to calculate peak runoff for future conditions in these areas. Problems with existing storm drainage facilities as identified in this Section are rated and developed into projects in Chapter 8.

6.1.1 Basin A

Basin 'A' contains 234 acres and is primarily comprised of undeveloped land outside the City's UGB. This basin is north of the City of Lowell and generally west of Moss Street. It is particularly of interest because it is the head waters for the Western Drainage through town. The portion inside the UGB is largely industrial zoned which contains two large buildings, some paved parking and two cul-de-sac dead end roads. There is a small portion (16.6 acres) of this basin that is east of Moss Street which is undeveloped and mostly within the city's UGB. Runoff from this area is piped under the roadway through a culvert.

Soil Type

Chehulpum Silt Loam (Map Unit 28)
 Hazelair Silty Clay Loam (Map Unit 52)
 Nekia Silty Clay Loam (Map Unit 89)
 Panther Silty Clay Loam (Map Unit 102)
 Philomath Silty Clay (Map Unit 107)
 Philomath Cobbly Silty Clay (Map Unit 108)
 Ritner Cobbly Silty Clay Loam (Map Unit 113)
 Rock Outcrop – Witzel Complex (Map Unit 116)

Slope

0-30%

Current Land Use

Industrial (I1) – 9.3 Acres
 Residential (R1) – 32.6 Acres
 Forest (F1 & F2) – 192.1 Acres

Peak Runoff (cfs)

25-Year Storm (Existing)	99.16
25-Year Storm (20-Year)	109.5
25-Year Storm (Buildout)	109.5

Existing Storm Drain System

Existing storm drainage facilities in Basin A include a small collection system within the industrial park and several culverts beneath roadways. Runoff originating from the industrial park is collected by a series of catch basins and discharged into a branch of the Western Drainage. Runoff originating from the undeveloped land on the east side of Moss Street crosses to the west through an 18-inch corrugated metal pipe (Culvert A1-C), then south under Seneca Street through a 24" PVC culvert. Flows continue to the south through an inline detention pond constructed at the time of the industrial park. Water is released from the detention pond where it continues to the south under 7th Street through a 24" corrugated metal pipe (CMP) before dispersing into a wetland. The wetlands are drained by the Western Drainage.

The culverts in this basin are estimated to lie at 2% or less and have no type of inlet/outlet structures. The 18" CMP culvert across Moss Street and has an estimated maximum capacity of 8.7 cfs. The 24" culverts are PVC and CMP and have estimated maximum capacities of 40.6 and 18.6 cfs respectively.

Present Problems

There is overland flow that sheets over the existing sidewalk onto Industrial Way. A shallow ditch should be constructed to collect and convey the overland flow around the roadway into the detention pond. This is not a major concern but the flow is carrying sediment and depositing it on the sidewalk and roadway.

The 18-inch pipe (Culvert A1-C) under Moss Street appears to be undersized for larger storm events, however there were no reports of any flooding in the area, likely due to its location outside of town. Any development east of Moss Street in this basin should study this pipe in more depth.

Future System

The undeveloped land in this basin within the City's UGB is composed of both industrial and residential. The industrial area already has a storm system in place for the roadway, however any large buildings or paved areas would need to be accounted for. The existing detention pond is likely not sized for any future improvements. It would likely need to be increased in size or another form of detention may be required. A downstream analysis should be completed to ensure no downstream deficiencies would be impacted due the increase in runoff. It is likely the 24" pipe at 7th Street will not handle any additional flows.

The residential area east of Moss Street would need to construct a storm drainage system including upsizing the culvert under Moss Street. The storm drainage system should include a water quantity system to detain flows to pre-existing conditions or examine the downstream system. Any increase in flow rates from this basin will carry through the remaining storm system adding to down stream capacity issues. Similar to the industrial area, the 24" culvert under 7th Street will not handle additional flows.

While calculating the future flows, it was anticipated the industrial area would be fully developed and a portion of the residential area would be utilized.

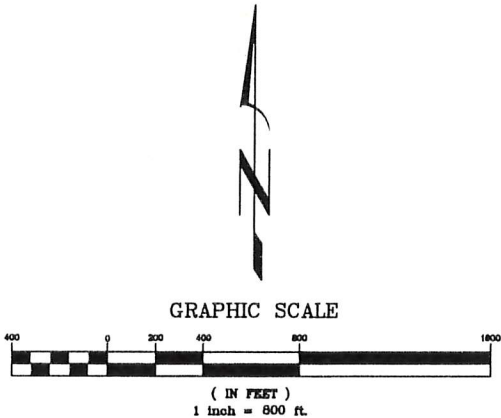
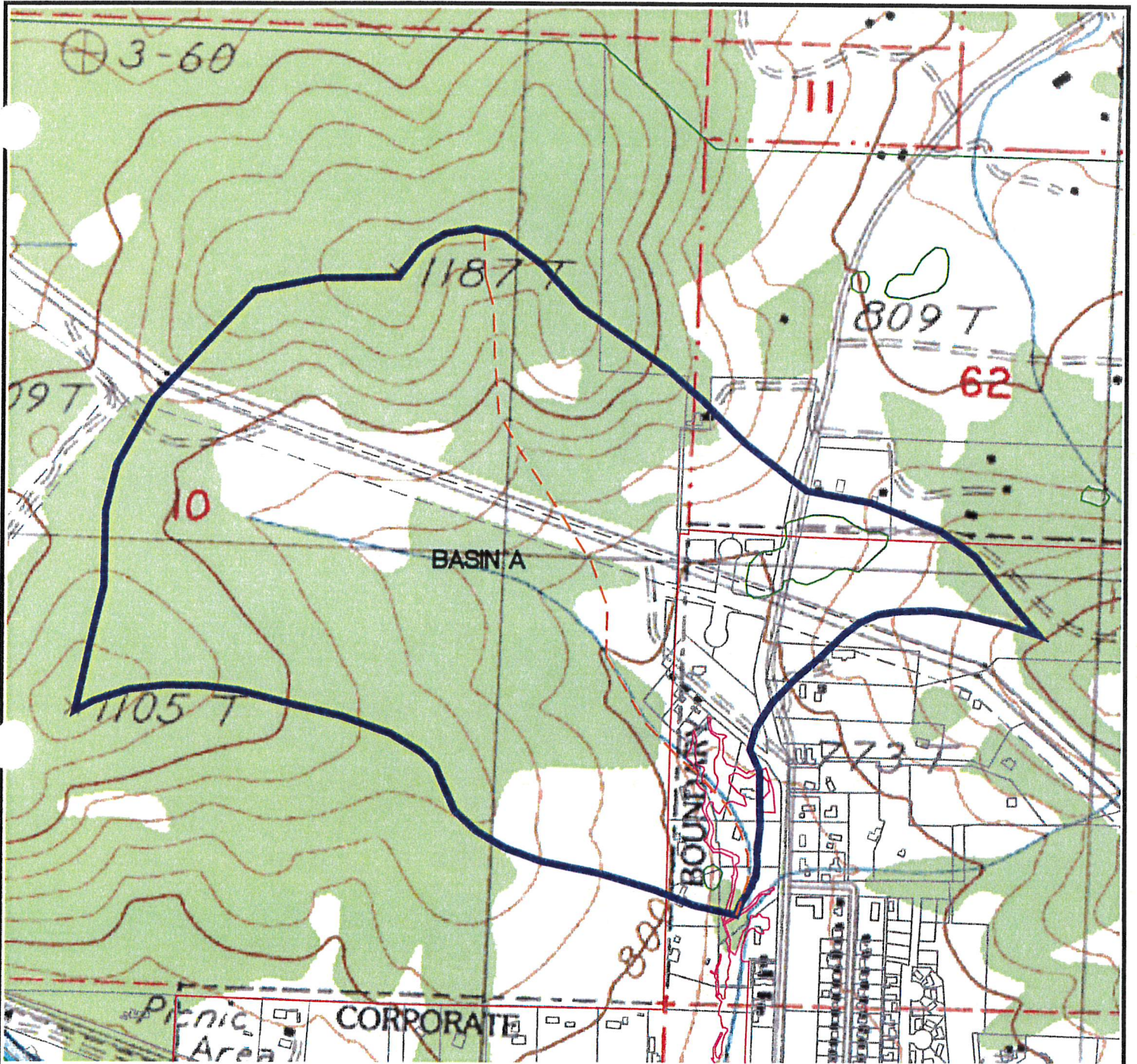

TC (25-yr)

LENGTH	TYPE	SLOPE	TIME
300	OVERLAND	0.29	17.0
2176	SHALLOW	0.14	19.5
1700	CREEK	0.03	8.4
TC (MINUTES)			44.9

6.1.2 Basin B

Basin B contains 60.4 acres of which 21 lay outside of the City's UGB. This basin lies to the west of the Western Drainage and has little effect on the city's storm system except for capacity in the Western Drainage. Development in this basin is sparse and not likely to expand. The majority of the area within the UGB is located in the Western Drainage draw and wouldn't support dense growth.

Soil Type

Nekia Silty Clay Loam (Map Unit 89)
Panther Silty Clay Loam (Map Unit 102)
Pengra Silt Loam (Map Unit 105)
Ritner Cobbly Silty Clay Loam (Map Unit 113)

Slope

0-20%

Current Land Use

Residential (R1) – 37.6 Acres
Public Lands (PL) – 1.7 Acres
Forest (F1) – 21.1 Acres

Peak Runoff (cfs)

25-Year Storm (Existing)	23.88
25-Year Storm (20-Year)	23.88
25-Year Storm (Buildout)	23.88

Existing Storm Drain System

There is very little storm water infrastructure in this basin. It is believed most runoff flows overland directly into the Western Drainage. There is a system of ditches and 12" culverts that take runoff from Marina Vista Drive and convey it south towards Pengra Road and into the Western Drainage. The Western Drainage crosses Pengra road through a 48" x 72" concrete box culvert (Culvert B1-C) into Dexter Lake.

Present Problems

There are no known storm drainage problems in this basin.

Future System

If this area were to develop further, measures should be taken to establish drainage easements for the Western Drainage, including the creek itself and appropriate setbacks to ensure water quality including vegetative filters and trees to provide shading. Detention for this basin should not be required, as appropriate setbacks from the creek will ensure no flooding. All future piping should be sized to convey flows from the area within the UGB at full buildout per current zoning requirements.

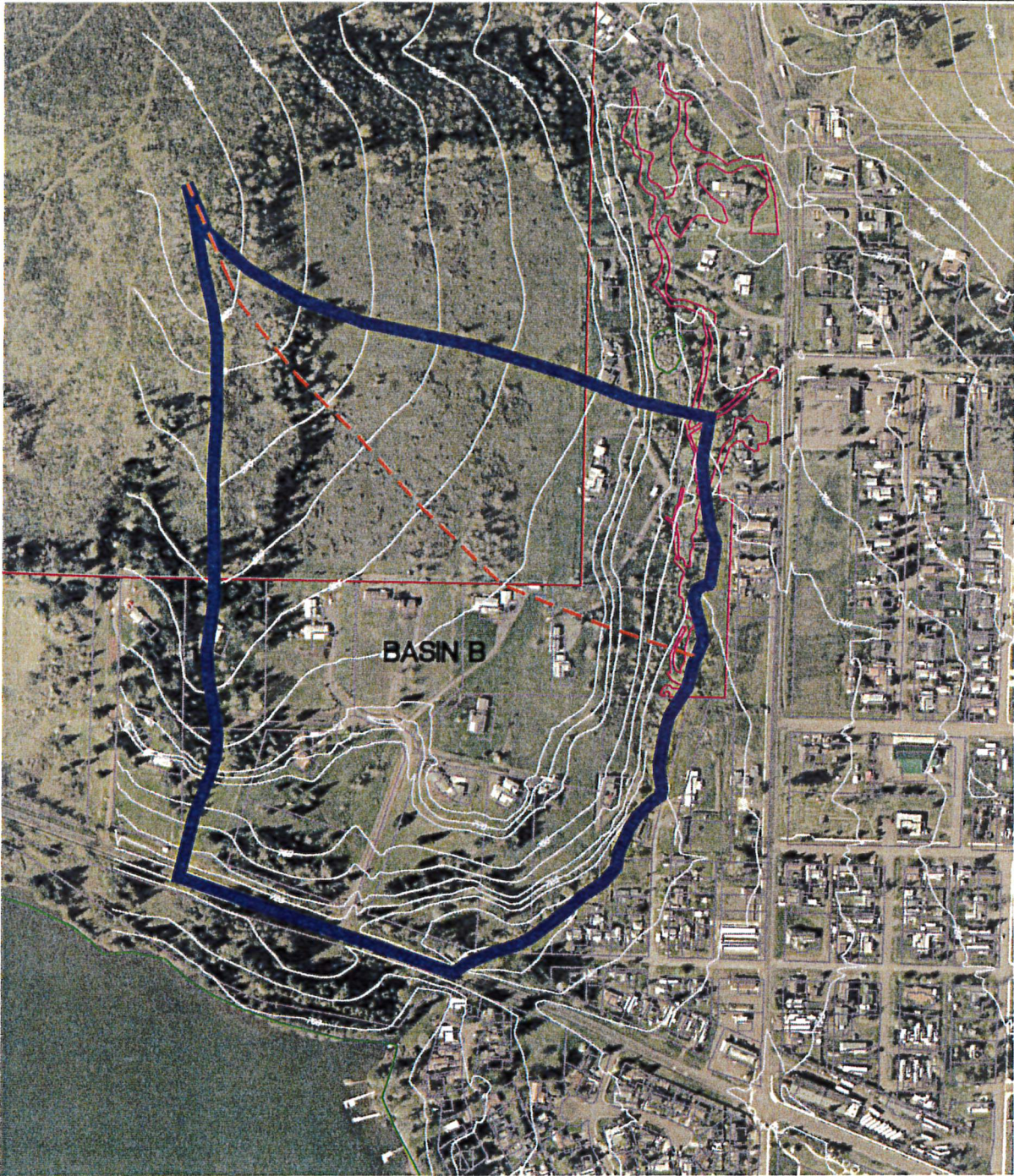

GRAPHIC SCALE



(IN FEET)
1 inch = 500 ft.

TC (25-yr)

LENGTH	TYPE	SLOPE	TIME
300	OVERLAND	0.02	49.4
1929	SHALLOW	0.11	19.7
TC (MINUTES)			69.1

6.1.3 Basin C

Basin C contains 107.6 acres of which 25.5 lay outside of the city's UGB. This basin lies to the north of town and contributes flow to the 6th Street drainage. There is a small area north of this basin that lies within the City's UGB and which topographic maps indicate drains to the north away from the City. Current storm drainage laws would not allow this water to be redirected through town. Most of this basin is currently undeveloped and lightly forested. There are a few residences on the north end of town (19.2 acres). The basin is bordered by Moss Street to the west and 6th Street to the south.

Soil Type

Dixonville-Philomath-Hazelair Complex (Map Unit 43)

Hazelair Silty Clay Loam (Map Unit 52)

Panther Silty Clay Loam (Map Unit 102)

Witzel Very Cobbly Loam (Map Unity 138)

Slope

0-35%

Current Land Use

Residential (R1) – 79.8 Acres

Public Lands (PL) – 2.3 Acres

Farm (E40) – 25.5 Acres

Peak Runoff (cfs)

25-Year Storm (Existing) 52.69

25-Year Storm (20-Year) 59.66

25-Year Storm (Buildout) 59.66

Existing Storm Drain System

Stormwater from this basin crosses Moss Street at two different locations. The first is from a small drainage at the northwest edge of the basin; runoff is collected along with drainage from Moss Street and conveyed through a 24" corrugated metal pipe (Culvert C3-C) into the western moss street ditch. It then makes it way south before converging with the 6th Street drainage.

The 6th Street drainage converges from three different directions (east along 6th Street, north and south along Moss Street) before being piped under Moss Street and into the Western Drainage. The 6th Street ditch carries flow from most of this basin which is still largely undeveloped, most of the storm system is a natural drainage way. As the natural drainage approaches the developed portion of the basin it is channelized into a roadside ditch on the north side of 6th Street. The ditch enters a pair of 24" CMP culverts before being combined with flow from the north and south ditches.

The flow from the north starts at the north edge of town in a natural drainage near 7th Street and flows into a roadside ditch that runs parallel to Moss Street. This ditch flows south to the convergence through several 12" corrugated culverts under private driveways.

The flow from the south is relatively small and drains property along the south side of 6th Street. The runoff is collected in a ditch which flows through an 18" corrugated culvert adjacent to the US Forest Service rear lot. Once the ditch approaches Moss Street it is piped under 6th Street through a 12" PVC culvert joining the 6th Street drainage and the flow from the north.

The combined flow is then conveyed under Moss Street to the west through a 36" CMP culvert (Culvert C1-C) where it meets drainage from the western Moss Street ditch. From there it is piped into a wetland that is branched off the main Western Drainage through two 24" HDPE culverts (Culvert C2-C). Currently this wetland is located on private property in an established channel. It is well covered with trees and the property owner has kept the surrounding areas well manicured free of briars and other intrusive plants.

The culverts in this drainage are estimated to lie at 2% or less and have no type of inlet/outlet structures. The 12", 18", 24" and 36" corrugated pipes have an estimated maximum capacity of 2.9 cfs, 8.7 cfs, 18.6 and 55.1 cfs, respectively based on the estimated 2% slope. The 12" PVC pipe has an estimated maximum capacity of 6.4 cfs based on 2% slope and the dual 24" HDPE pipes have a combined estimated capacity of 81.2 cfs.

Present Problems

There are no known storm drainage problems with the 6th Street drainage. The existing culverts appear to be sized adequately to handle existing flows. Although there are no capacity issues in this basin, there are other problems. The drainage west of Moss Street is across private property, this should be addressed by the City to either acquire this land as a park/open space or a drainage easement so that it can take measures to protect the natural water quality features that exist, such as vegetation and shading from trees.

The 24" Culvert (Culvert C3-C) that crosses under Moss Street near 7th Street has some reported flooding problems downstream. It was reported that at higher flows the water from this culvert is not contained in the roadside ditch and floods the adjacent property.

Future System

As this basin is largely undeveloped and there are several large tax lots available, this area is viable for development. With the City expecting a large amount of growth within the coming decades it was assumed the residential impact in this basin would be significant. The 6th Street Drainage should be piped from Moss Street east to the edge of any development. This pipe should be used as a trunk line for the area and needs to be sized accordingly. Our calculations indicate that a 36" smooth walled PVC or HDPE pipe at a minimum slope of 0.5% would be appropriate.

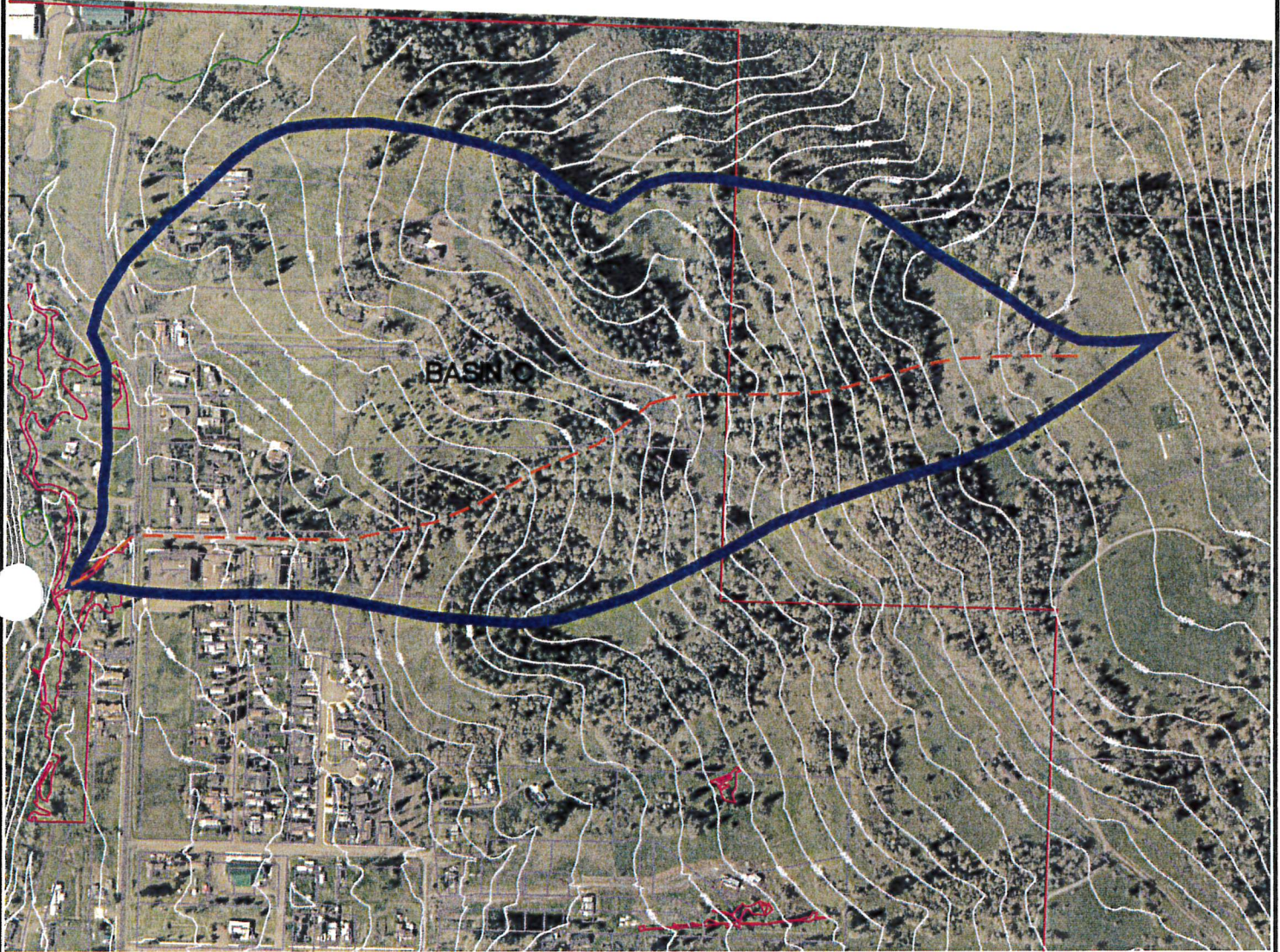

GRAPHIC SCALE



(IN FEET)
1 inch = 600 ft.

TC (25-yr)

LENGTH	TYPE	SLOPE	TIME
300	OVERLAND	0.03	40.3
1570	SHALLOW	0.22	11.2
625	CREEK SEG. 1	0.14	1.8
1274	CREEK SEG. 2	0.04	3.6
TC (MINUTES)			56.9

6.1.4 Basin D

Basin D encompasses 166.2 acres in the east-central portion of Lowell. Approximately 45.4 acres of the basin lies outside the City Limits extending up the western slope of Butte Disappointment. Basin D lies adjacent to Basin C on the south. The northerly and southerly boundaries of Basin D are along adjacent ridgelines located on the westerly slopes of the mountain. One of the City's unnamed seasonal creeks, referred to as the 4th Street Drainage, collects runoff from within the basin. The upper portion of the 4th Street Drainage is a seasonal stream and the lower portion runs through a culvert along north side of 4th Street. It connects with the Western Drainage approximately 350 feet west of the intersection of Moss and 4th Streets.

Basin D has been divided into three subbasins for modeling purposes. Each subbasin has a different drainage path terminating at the Western Drainage. Subbasin D1 encompasses the majority of the area north of 4th Street and east of Moss Street, including areas outside the City Limits to the east. Stormwater runoff from Subbasin D1 follows the 4th Street storm drainage system described above. Subbasin D2 occupies the area bounded by Moss Street on the west, Hyland Drive on the east, Pengra Road on the south, and 4th Street on the north. Runoff from Subbasin D2 is collected in a storm drain system east of Moss Street, mainly along 3rd Street. Subbasin D3 includes the area west of Moss Street and north of Pengra Road. Runoff from Subbasin D3 occurs as overland sheet flow directly to the Western Drainage or passes through an open ditch as it approaches the Western Drainage.

Soil Type

Courtney Gravelly Silty Clay Loam (Map Unit 34)
 Dixonville-Philomath-Hazelair Complex (Map Unit 43)
 Hazelair Silty Clay Loam (Map Unit 52)
 Panther Silty Clay Loam (Map Unit 102)
 Pengra Silt Loam (Map Unit 105)
 Witzel Very Cobbly Loam (Map Unit 138)

Slope

0-75%

Current Land Use

Residential (R1) – 95.3 Acres
 Residential (R3) – 10.5 Acres
 General Commercial (C1) – 7.5 Acres
 Public Lands (PL) – 7.5 Acres
 Forest (F1) – 6.4 Acres
 Farm (E40) – 39.0 Acres

Peak Runoff (cfs)

Storm Event	Basin D1	Basin D2	Basin D3
25-Year Storm (Existing)	60.82	25.42	18.43
25-Year Storm (20-Year)	69.13	26.23	19.01
25-Year Storm (Buildout)	69.13	26.23	19.01

Existing Storm Drain System

Subbasin D1 – Subbasin D1 encompasses the majority of the area north of 4th Street and east of Moss Street, including areas outside the City Limits to the east. Runoff from Butte Disappointment makes its way down the hill toward the intersection of 4th Street and Hyland Drive. Recent development in this area has led to the construction of storm drainage improvements. The Hyland Butte Manufactured Home

Park, as a part of their development, replaced an existing 18" CMP with a 30" concrete pipe to convey runoff down the north side of 4th Street. The 30" pipe was recently extended by another development connecting it to an existing 32" PVC pipe. Flow continues to the west where it is joined with runoff from Carol Street. The pipe is then upsized to 36" before being discharged into another ditch. Flow from this pipe is joined with a backyard ditch to the north and piped again through a large ditch inlet constructed over a 42" concrete pipe where it is joined with runoff from "D" Street. From there the pipe is upsized to a 48" concrete pipe extending to Moss Street. At Moss Street the drainage is joined by a roadside ditch from the north that runs parallel to Moss Street, and from the south by flows from a pair of catch basins on 4th Street. Stormwater is then piped under Moss Street through a pair of 60" concrete culverts (Outfall D1) into a recently constructed swale. The swale is drained by five 24" culverts (Culvert D1-C) under a private road. The above described swale then extends to the Western Drainage.

The culverts in this drainage are estimated to lie at slopes 4% or less. The following table presents the sizes and materials of the various pipes identified within Subbasin D1 along with estimated maximum capacities based on the indicated pipe slopes.

Location	Size	Material	Estimated Slope	Maximum Capacity (cfs)
4 th Street east of Hyland Drive	30"	Concrete	4%	88
4 th Street east of Hyland Drive	32"	PVC	4%	105
4 th Street west of Carol Street	36"	Concrete	3.5%	135
4 th Street east of D Street	42"	Concrete	3.5%	202
4 th Street west of D Street	48"	Concrete	3.5%	289
4 th Street at Moss Street	2 @ 60"	Concrete	2%	400+
4 th Street west of Moss Street	5 @ 24"	Concrete	2%	172

The maximum capacity of the two 60" concrete pipes beneath Moss Street at 4th Street is uncertain due to standing water conditions within the pipes and vegetation downstream. Vegetation should be removed periodically from the downstream channel to maintain capacity of the system.

Subbasin D2 – Subbasin D2 occupies the area bounded by Moss Street on the west, Hyland Drive on the east, Pengra Road on the south, and 4th Street on the north. Runoff from Subbasin D2 begins at the top of Hyland Butte and is collected in a storm drain system along 3rd Street east of Moss Street which includes a series of ditches and small diameter culverts. Flows proceed to the west where they are collected by a series of poured in place manholes/inlets along Moss Street. The manholes are joined together with a 12" concrete pipe that direct runoff to the intersection of 3rd and Moss Street where it is conveyed to the west under Moss Street through a pair of 12" concrete pipes (Outfall D2). The pipes discharge into an overgrown swale that drains under Damon Street through two 24" corrugated pipes (Culvert D2-C) and eventually into the Western Drainage.

The culverts in this drainage are estimated to lie at 3% or less and have no type of inlet/outlet structures. It is assumed that the small diameter concrete culverts discussed above are at least 8" diameter. Based on this assumption and the estimated 3% slope, they would have a maximum capacity of about 2.2 cfs, each. The 12" diameter concrete pipe along 3rd Street placed at a 3% slope has a maximum capacity of about 6.6 cfs. The maximum capacity of two parallel 12" concrete pipes at 3% slope (Outfall D2) is 13.2 cfs. The maximum capacity of two parallel 24" corrugated metal pipes at 2% slope (Culvert D2-C) is 37.2 cfs.

Subbasin D3 – Subbasin D3 includes the area west of Moss Street and north of Pengra Road. Runoff from Subbasin D3 occurs as overland sheet flow directly to the Western Drainage or passes through open ditches as it approaches the Western Drainage.

The Western Drainage defines the westerly boundary of this subbasin. There are several residences along the creek with driveways that cross it. There is a pair of 30" corrugated metal pipes (Culvert D3-C) on the driveway located approximately 380 feet south of 6th Street. Further downstream there is a pair of 36" corrugated metal pipes (Culvert D4-C) on a driveway located near the extension of 3rd Street. The estimated maximum capacity of the described culverts is 67.8 cfs for the pair of 30" pipes based on 2% slope, and 110.2 cfs for the pair of 36" pipes based on 2% slope.

Present Problems

Subbasin D1 – There are no known capacity problems along the 4th Street drainage. A recent storm drainage study provided for Hyland Butte Manufactured Homes identifies other deficiencies. The discharge from the 30" concrete pipe under Hyland Drive should be extended and connected to the 32" pipe downstream. This has already been completed by the development in that area. The other problem is where the backyard drainage meets the discharge from the described 36" pipe. The 36" pipe should be extended and connected to the 42" pipe. A ditch inlet should be installed to collect flows from the backyard drainage.

The swales from Moss Street west to the Western Drainage are currently grassed, with flat bottoms. These are considered beneficial for water quality. Additional benefits could be realized by providing some trees for shading along the swales.

On the east side of D Street just north of 4th Street there is an existing culvert that appears to lie beneath an existing residence. This should be investigated, and if the pipe does lie beneath the residence it should be abandoned and relocated.

Subbasin D2 – The system of ditches and culverts within Subbasin D2 appears to be adequately sized for the rate of runoff that occurs in this area. The parallel 12" pipes (Outfall D2) which cross Moss Street at 3rd Street appear to be too small for flows resulting from larger events. It is recommended that these pipes be replaced with minimum 18" HDPE or PVC pipes laid at a minimum 2% slope. There is also a need for a drainage easement along the extension of 3rd Street between Moss Street and the Western Drainage. Additionally, maintenance to the existing swale is recommended at this time to remove vegetation.

There is a culvert that discharges into Paul Fisher Park at a point approximately 150 feet north of 3rd Street and 150 feet east of Moss Street. Flows from this pipe presently travel overland into an area drain located adjacent to Moss Street. This pipe should be extended underground and connected into the described area drain.

Subbasin D3 – No capacity deficiencies have been identified in this area, although there is only limited infrastructure at this time. The dual 24" corrugated pipes under Damon Street are adequately sized for present and future flows. Drainage easements should be established across private properties upstream and downstream of these culverts. The Western Drainage that runs adjacent to this basin is within 20 feet of several existing structures. A drainage easement or open space should be acquired, preferably away from the structures, and the drainage relocated. Relocation of the drainage could include rehabilitation with riparian areas, shading, and pooling to improve water quality. The existing culverts along the Western Drainage are undersized for calculated future flows. It is recommended that these pipes be replaced with minimum 36" HDPE or PVC pipes placed at minimum 3% slope.

Future System

Subbasin D1 – This area already has two new developments under construction and another phase planned. It is assumed that additional development will occur in the future. The primary storm drainage system through this basin is adequately sized to handle calculated present and future flows. Extending the existing trunk storm drain as development occurs will ensure adequate service for this basin.

Subbasin D2 – This basin is developed very close to its maximum density at this time. There is very little land available for development. Plans to further develop Paul Fisher Park should include extension of the storm drain that presently discharges into the park to an area drain located on the easterly shoulder of Moss Street. In addition, area drains should be provided with any new development proposed at the park, including a restroom facility and/or skate park.

Subbasin D3 – Most of the runoff from this area drains directly to the Western Drainage. Any future development should include drainage easements or opens space with appropriate buffers for the Western Drainage as well as the ditch along the extension of 3rd Street. All other drainage should be routed directly into the Western Drainage.

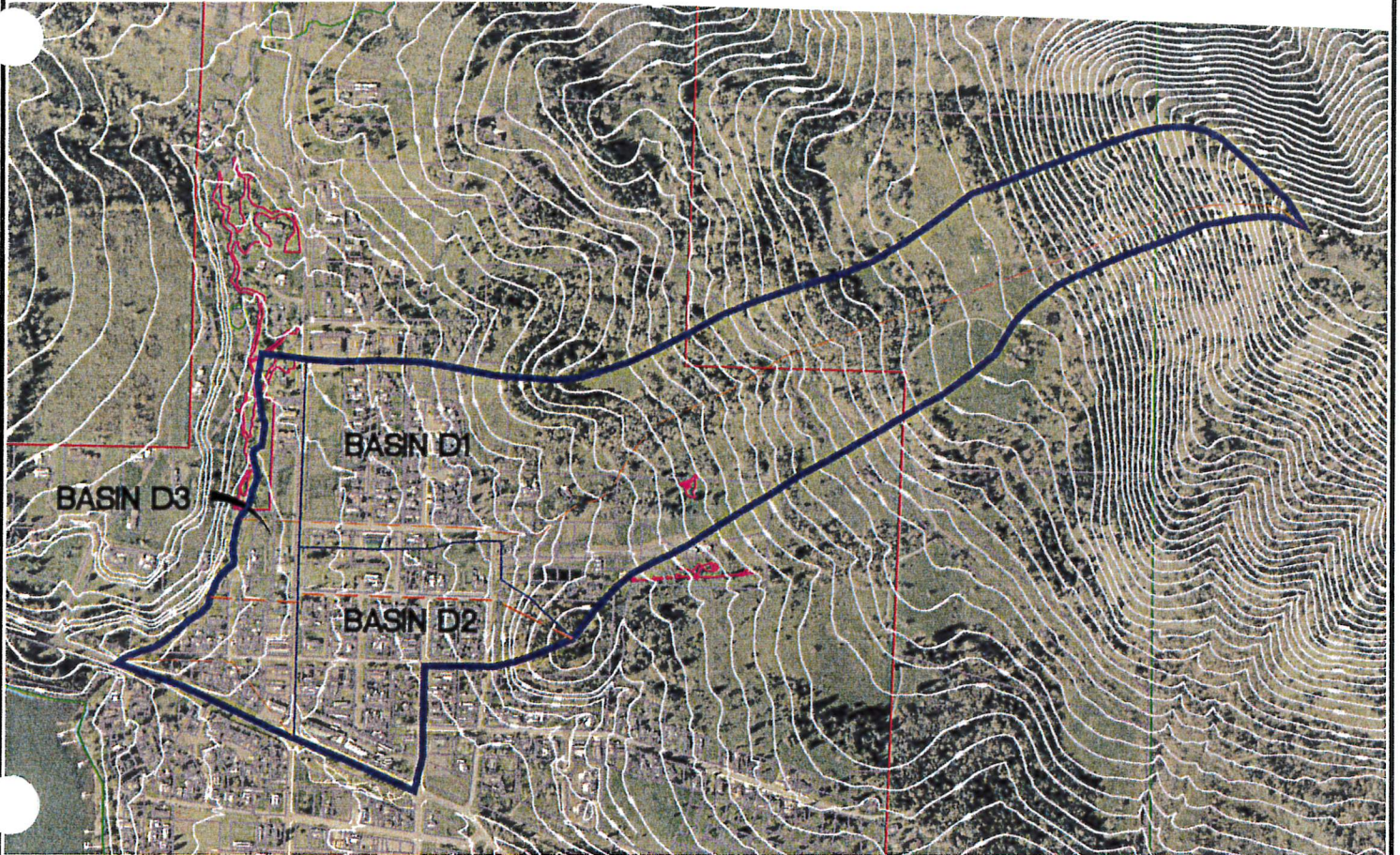

TC-D1 (25-yr)

LENGTH	TYPE	SLOPE	TIME
300	OVERLAND	0.35	15.7
1372	SHALLOW	0.51	6.4
2544	SHALLOW	0.18	19.7
977	CREEK	0.08	1.5
1324	30" CULVERT	0.03	1.2
TC (MINUTES)			44.5

TC-D2 (25-yr)

LENGTH	TYPE	SLOPE	TIME
300	OVERLAND	0.22	18.8
1810	PIPE	0.05	3.1
TC (MINUTES)			21.9

TC-D3 (25-yr)

LENGTH	TYPE	SLOPE	TIME
300	OVERLAND	0.02	3.0
840	DITCH	0.04	4.5
TC (MINUTES)			7.5

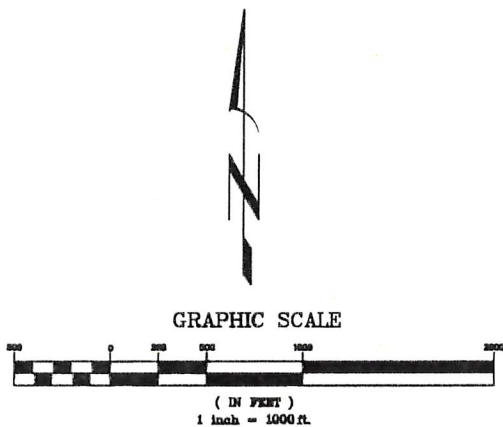

6.1.5 Basin E

Basin E occupies 150.9 acres in the southeastern portion of the City and on the southwesterly slope of Butte Disappointment. Approximately 55.7 acres of Basin E lie outside the City Limits on the upper portion of Butte Disappointment. The creek identified in this Master Plan as the Eastern Drainage flows southwest through the basin and ultimately discharges into Dexter Lake. A storm drainage system on East 1st Street collects runoff generated along the street and to the north, east of Trailblazer Court. This collection system is connected to the 30" culvert that crosses 1st Street approximately 350 feet east of Hyland Drive. The Eastern Drainage then continues southerly, crosses an old railroad alignment through a 36" by 48" concrete box culvert, and then crosses West Boundary Road through parallel 36-inch and 42-inch diameter concrete culverts.

Basin E has been divided into two subbasins for modeling purposes. Subbasin E1 occupies the northern portion of the basin and corresponds to the watershed area of the Eastern Drainage north of 1st Street. Subbasin E2 is situated in the southern portion of the basin and corresponds to areas which either drain directly to Dexter Lake or contribute flows to the Eastern Drainage south of 1st Street.

Soil Type

Dixonville-Philomath-Hazelair complex (Map Unit 43)
 Hazelair Silty Clay Loam (Map Unit 52)
 Oxley Gravelly Silt Loam (Map Unit 100)
 Salkum Silty Clay Loam (Map Unit 121)
 Witzel Very Cobbly Loam (Map Unit 138)

Slope

0-75%

Current Land Use

Residential (R1) – 87.8 Acres
 Public Lands (PL) – 7.4 Acres
 Forest (F1) – 20.3 Acres
 Farm (E40) – 35.4 Acres

Peak Runoff (cfs)

Storm Event	Basin E1	Basin E2
25-Year Storm (Existing)	47.28	30.32
25-Year Storm (20-Year)	54.19	31.51
25-Year Storm (Buildout)	54.19	31.51

Existing Storm Drain System

Subbasin E1 – The majority of this basin is undeveloped, and the storm water runoff is collected and conveyed in a natural drainage channel referred to as the Eastern Drainage. As the channel approaches the developed area it crosses an existing residential lot and subsequently passes under East 1st Street through a 30" culvert (Culvert E3-C). The culvert discharges between several existing residences and drains to a low area just north of Pengra Road. The low area is drained through an existing 36"x48" concrete box culvert (Culvert E1-C) that discharges to a roadside ditch which runs parallel to Pengra Road. The ditch flows to the east along the roadside and then passes through parallel 36" and 42" concrete culverts (Culvert E2-C). These pipes discharge into a wetland area adjacent to Dexter Lake.

Subbasin E2 – This subbasin includes a recent residential development. A series of catch basins and storm drain piping have been constructed to collect roadway runoff and convey it down Wetleau Drive to

an access road located within a future phase of the development. An existing 24" storm drain pipe is present along the access road and terminates just upstream of the 36" x 48" box culvert (E1-C). Based on as-built drawings for the storm drain, a maximum capacity of 17.1 cfs is estimated for the 24" pipe, while 12" piping located upstream of the 24" pipe has a maximum capacity of approximately 10.4 cfs.

Three culverts have been identified in Basin E including a 30" culvert (Culvert E3-C) of mixed material (CMP upstream, PVC downstream); a 36" x 48" concrete box culvert (E1-C) with headwall; and parallel 36" and 42" concrete culverts (E2-C). The estimated maximum capacity of these culverts is as indicated in the following table.

Location	Size	Material	Estimated Slope	Maximum Capacity (cfs)
150' east of Hyland Drive (E1-C)	36" x 48"	Concrete	2%	180+
W. Boundary Rd. east of Parker Ln. (E2-C)	36" and 42"	Concrete	2%	267
1 st Street east of Hyland Drive (E3-C)	30"	CMP & PVC	2%	20+/-

Present Problems

Subbasin E1 – The Eastern Drainage flows through several residential lots but does not appear to be located within a drainage easement. A 20-foot wide alley extends south from East 1st Street beginning approximately 110 feet west of the crossing of the Eastern Drainage. It may be possible to relocate the Eastern Drainage to this alley in order to eliminate it from crossing private land in this area.

As previously indicated, the 30" culvert which crosses East 1st Street easterly of Hyland Drive (Culvert E3-C) is undersized for calculated peak flows within the Eastern Drainage based on the 25-year design storm. It is recommended that the pipe be replaced with a minimum 30-inch HDPE or PVC pipe at a slope of at least 2% in order to provide adequate capacity for calculated future peak flows.

Subbasin E2 – No capacity deficiencies have been identified for storm drainage facilities within Subbasin E2. The existing storm drainage system is considered adequate for calculated current and future flows based on the 25-year storm. This area has been developed relatively recently and therefore the facilities are expected to have many more years of useful service life.

Future System

Subbasin E1 – It is assumed that additional development will occur in this portion of the City during the coming years. Because of the relatively steep terrain, careful planning of storm drainage facilities will be critical to prevent damage to downstream properties resulting from excess or uncontained runoff. Storm drainage may be routed to the Eastern Drainage. The 30" HDPE or PVC culvert recommended above for the Eastern Drainage at the crossing of East 1st Street is appropriate to convey calculated future peak flows based on buildout conditions within the present City Limits using the 25-year design storm. Any new development should include onsite detention and discharge control to facilitate stormwater discharge at no greater than the predeveloped rate.

Subbasin E2 – There are already plans for expanding development in this area. The existing storm drain improvements have adequate capacity for development south of East 1st Street. Any development north of East 1st Street should be routed to the Eastern Drainage. As indicated above, any new development should include onsite detention and discharge control to facilitate stormwater discharge at no greater than the predeveloped rate, regardless of the drainage route.

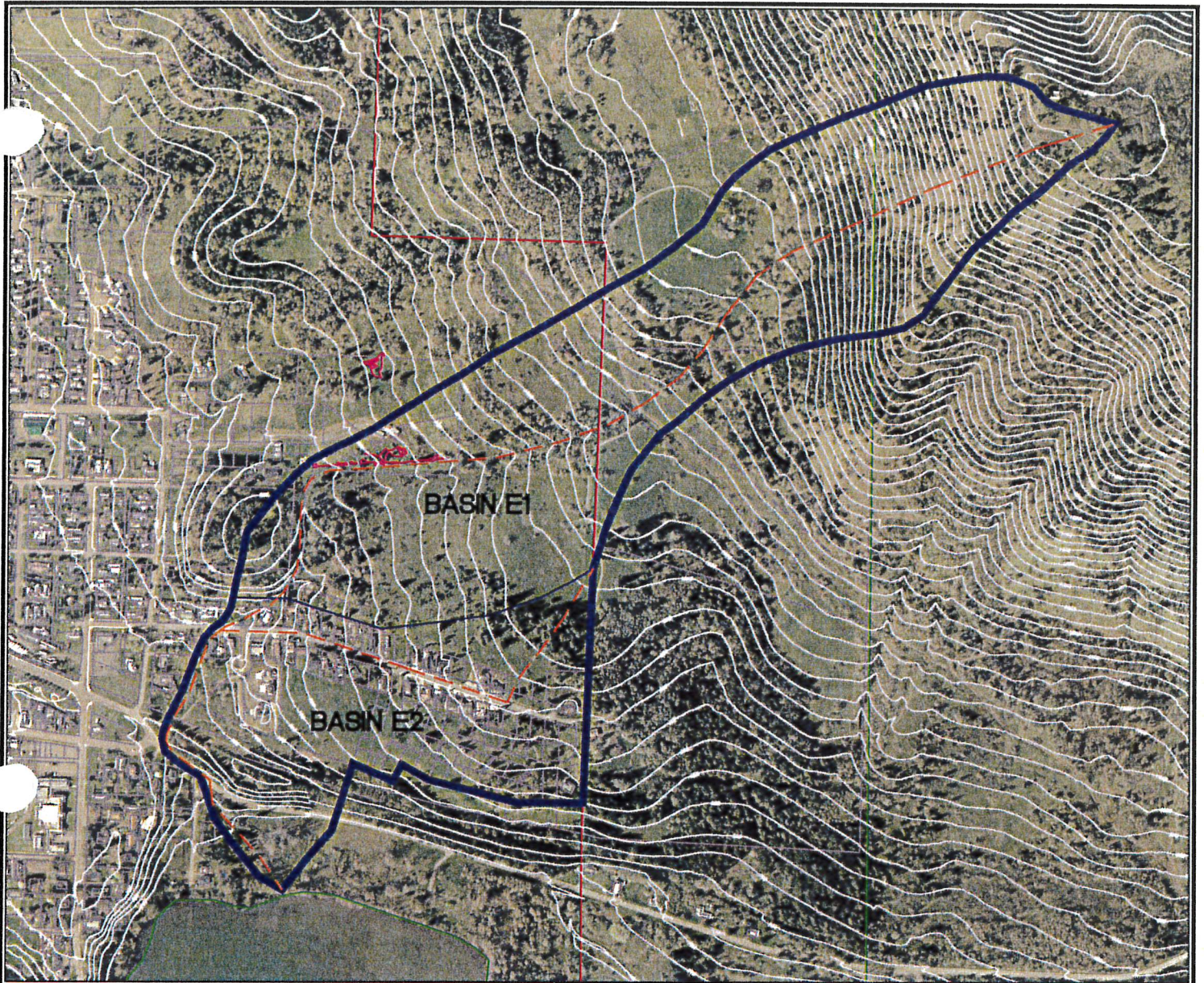

TC - E1 (25-yr)

LENGTH	TYPE	SLOPE	TIME
300	OVERLAND	0.09	26.7
1513	SHALLOW	0.53	6.9
1094	SHALLOW	0.18	8.7
2475	CREEK	0.14	2.9
TC (MINUTES)			45.2

TC - E2 (25-yr)

300	OVERLAND	0.04	37.5
524	SHALLOW	0.13	4.8
555	GUTTER	0.11	0.6
995	PIPE	0.11	0.9
TC (MINUTES)			43.8

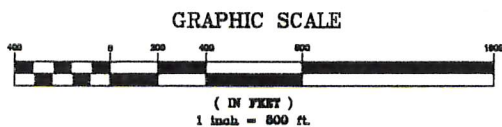

6.1.6 Basin F

Basin F occupies 31.8 acres in the southeasterly portion of Lowell and is bordered by Pioneer Street on the west, 2nd Street on the north, and Dexter Lake on the south. The northeasterly corner of Basin F is located at the top of Hyland Butte. The easterly boundary of Basin F extends down the southwesterly slope of Hyland Butte to a point located approximately 50 feet east of the intersection of East Main Street and Pengra Road, and then turns southeast and extends to a point on the north shore of Dexter Lake approximately 400 feet east of Parker Lane. The majority of the runoff in this basin is conveyed by several storm drainage systems into the Eastern Drainage. Runoff in the southern portion of the basin discharges directly into Dexter Lake.

For modeling purposes, Basin F has been divided into two subbasins. Subbasin F1 in the north represents the area which contributes flows to the Eastern Drainage. Subbasin F2 in the south represents the area from which runoff occurs directly to Dexter Lake.

Soil Type

Courtney Gravelly Silty Clay Loam (Map Unit 34)
 Hazelaire Silty Clay Loam (Map Unit 52)
 Oxley Gravelly Silt Loam (Map Unit 100)
 Salkum Silty Clay Loam (Map Unit 121)
 Witzel Very Cobbly Loam (Map Unit 138)

Slope

0-75%

Current Land Use

Residential (R1) – 17.5 Acres
 Residential (R3) – 0.4 Acre
 General Commercial (C1) – 3.0 Acres
 Public Lands (PL) – 10.9 Acres

Peak Runoff (cfs)

Storm Event	Basin F1	Basin F2
25-Year Storm (Existing)	16.72	9.39
25-Year Storm (20-Year)	17.26	9.39
25-Year Storm (Buildout)	17.26	9.39

Existing Storm Drain System

Subbasin F1 – Lane County has constructed two separate storm systems within this basin. The first is along the north side of Pengra Road from Pioneer Street to Hyland Drive. During improvements to Pengra Road the County installed a pair of catch basins at Pioneer Street. These catch basins drain through a pollution control manhole and discharge into a road side ditch. The ditch flows east towards Hyland Drive where it collects in a small pond and is discharged through an 18" culvert (Culvert F1-C) into a ditch which drains to the Eastern Drainage.

The second system begins at the intersection of Main Street and Pioneer Street. Stormwater is collected by four catch basins and conveyed to the east through a 15" concrete pipe where it connects to the storm drain system at the intersection of Main Street and Pengra Road. The County reconstructed this intersection and provided two catch basins within the intersection and several area drains to collect surface runoff outside the roadway. Stormwater is conveyed, along with the runoff from the Main Street and Pengra Road drainage, under Pengra Road through an 18" concrete pipe (Outfall F1) that discharges

into the Eastern Drainage. There is an additional 12" concrete pipe (Culvert F2-C) installed under Pengra Road for additional surface runoff not collected by the area drains.

Subbasin F2 – Most of this basin drains directly into Dexter Lake. Within this basin there is a set of catch basins constructed by Lane County at the south end of Pioneer Street as you first enter town. They collect runoff from Pioneer Street and discharge it into Dexter Lake through a 12" HDPE pipe (Outfall F2). The plans indicated the 12" outfall has rip rap protection to prevent erosion, but no water quality element.

Present Problems

Subbasin F1 – No roadway drainage problems have been identified within this basin. The improvements developed by Lane County serve this area well. During reconnaissance completed by HBH Consulting Engineers, ponding was observed adjacent to Hyland Drive near Pengra Road. This could be eliminated by lowering the culvert under Hyland Drive or by filling in the low area along the ditch. However, the low area provides natural detention and the grassed ditch is beneficial for water quality. It may be of more benefit to leave this as it is until the adjacent property is developed.

Subbasin F2 – There are no known storm drainage problems in this basin.

Future System

Subbasin F1 – The majority of this basin is already built to capacity. There is a small amount of commercial property and a few residential lots available for development, but very minimal impact is anticipated on the existing storm drainage system.

Subbasin F2 – There is very little available land for future development in this basin with most tax lots already occupied. No impact is anticipated to the storm drainage system in this area.

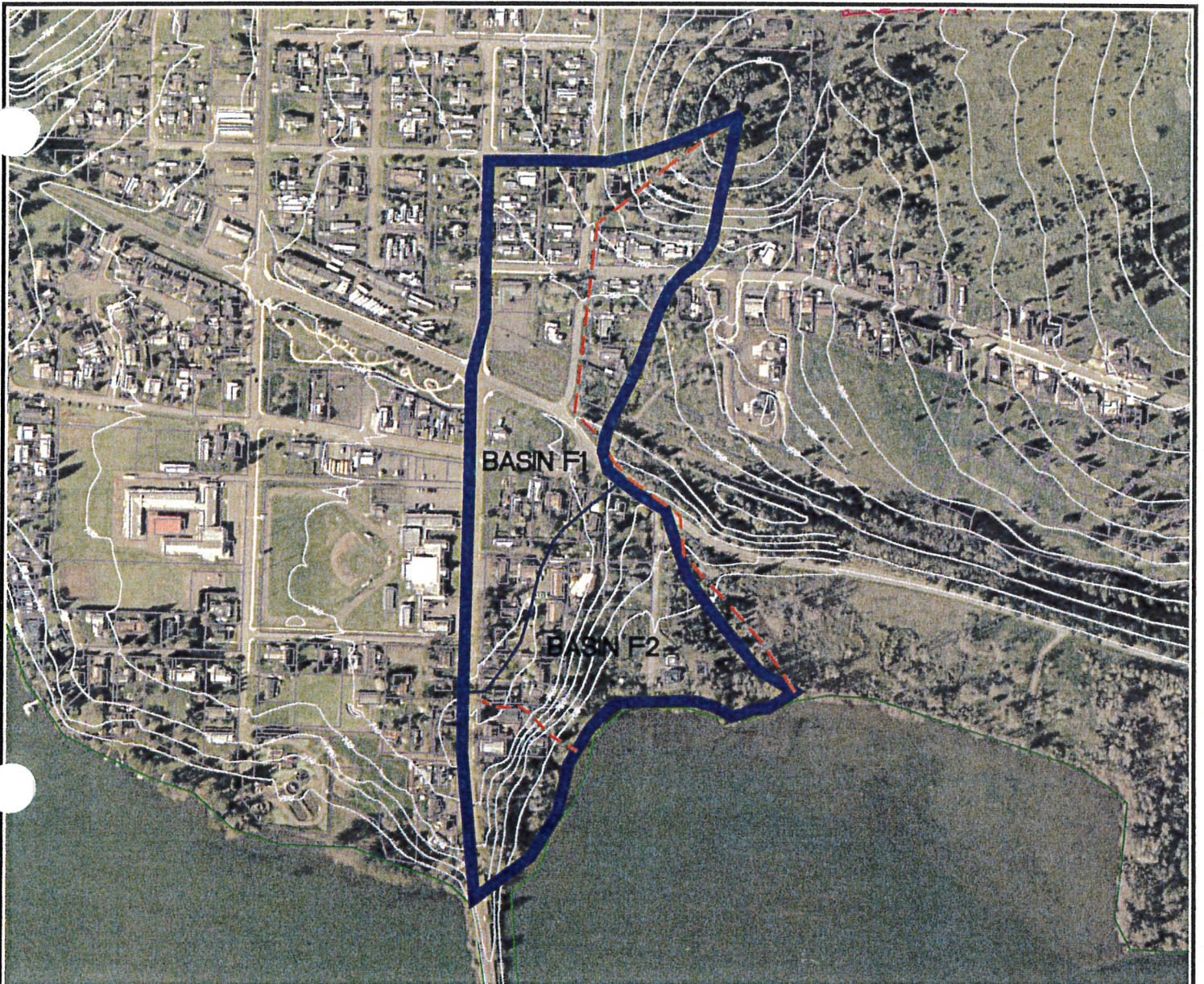

TC - F1 (25-yr)

LENGTH	TYPE	SLOPE	TIME
300	OVERLAND	0.15	22.1
288	SHALLOW	0.21	2.1
794	DITCH	0.04	4.5
TC (MINUTES)			28.7

TC - F2 (25-yr)

LENGTH	TYPE	SLOPE	TIME
175	OVERLAND	0.05	22.0
94	SHALLOW	0.42	1.0
100	SHALLOW	0.10	2.1
TC (MINUTES)			25.1



GRAPHIC SCALE



(IN FEET)
1 inch = 500 ft.

6.1.7 Basin G

Basin G encompasses a total of 64.7 acres on the peninsula bounded by Pengra Road on the north and by Dexter Lake on the south. The easterly boundary of Basin G is formed by Pioneer Street. Land use in Basin G includes single and multi-family residential, downtown commercial and public lands. Lundy Elementary, Lowell High School, Hyland Cemetery, and the City of Lowell wastewater treatment plant are all located within this basin.

Ground surfaces within Basin G slope gently to the west and south except within about 400 feet of the lake shore where grades become steeper. Runoff in Basin G generally occurs as overland flow or within roadside ditches along the shortest of several routes ultimately discharging into Dexter Lake. For modeling purposes, Basin G has been divided into four subbasins which represent the contributing areas to each of four separate drainage paths.

Subbasin G1 encompasses 13.9 between Alder and Moss Streets south of Pengra Road. Most of the stormwater runoff generated within Subbasin G1 is conveyed by a storm drainage system which discharges into Dexter Lake through an outfall located approximately 400 feet south of Pengra Road. Portions of the subbasin located west of Alder Street drain directly to the lake.

Subbasin G2 encompasses 16.8 acres from Moss Street east to Pioneer Streets and from Pengra Road south to Lakeview Street. Ground surfaces within this subbasin are relatively flat. Runoff generally flows to the west and is collected in a storm drain system on Moss Street at which point the runoff flows south and discharges into Dexter Lake via an outfall located on the south end of Moss Street near the treatment plant.

Subbasin G3 encompasses 25.8 acres primarily to the west of Moss Street and south of West Main Street. Ground surfaces within this subbasin generally slope to the south and west ranging from about 2% to 20% slope. Runoff generated in Subbasin G3 occurs overland by a variety of routes discharging directly into Dexter Lake.

Subbasin G4 lies in the southeastern corner of Basin G adjacent to Dexter Lake, Pioneer Street, and Lakeview Avenue. Its western boundary divides the wastewater treatment plant property. Runoff occurs overland directly into Dexter Lake.

Soil Type

Courtney Gravelly Silty Clay Loam (Map Unit 34)

Pengra Silt Loam (Map Unit 105)

Salkum Silty Clay Loam (Map Unit 121)

Slope

0-20%

Current Land Use

Residential (R1) – 33.2 Acres

Residential (R3) – 0.8 Acre

General Commercial (C1) – 0.1 Acre

Downtown Commercial (C2) – 5.8 Acres

Public Lands (PL) – 24.8 Acres

Peak Runoff (cfs)

Storm Event	Basin G1	Basin G2	Basin G3	Basin G4
25-Year Storm (Existing)	11.17	11.66	23.13	6.80
25-Year Storm (20-Year)	11.17	12.45	23.13	6.80
25-Year Storm (Buildout)	11.17	12.45	23.13	6.80

Existing Storm Drain System

Subbasin G1 – This subbasin includes relatively dense residential development and has an existing storm drainage system along Loftus Avenue. The stormwater runoff is piped to the west between several residences to Alder Street, and then through a catch basin and eventually to an outfall at Dexter Lake. There is a series of ditches and culverts along West Main Street which drains runoff to the west towards Alder Street where it then flows to the north towards the catch basin from the Loftus Avenue system.

The pipe size for the Loftus system is 12” but is upsized to an 18” pipe where it extends to the lake (Outfall G1). The culverts along West Main Street consist of 10” and 12” concrete pipes. The culverts in this subbasin are estimated to lie at a slope of 1% or less and have no type of inlet/outlet structures. The culverts have estimated maximum capacities of 2.3 cfs and 3.8 cfs, respectively. The 18” outfall from the Loftus Street system has an estimated maximum capacity of 16.0 cfs based on an assumed 2% slope and no backwater effects.

Subbasin G2 – This basin has several storm water components. Unfortunately this basin was incredibly difficult to map as there is no know as-built information other than that provided by Lane County for improvements on Pengra Road. Improvements to Pengra Road in 2002 by the County included the construction of a storm drainage system which collected runoff and conveyed it down Moss Street. The as-builts conclude near the intersection of Moss and West Main, but the system continues south along Moss Street. We have been informed that this is a 36” concrete pipe and outfalls to Dexter Lake (Outfall G2). Additionally, there is a possible break in the pipe near the wastewater treatment plant by the gate.

The 36” concrete pipe (Outfall G2) is estimated to lie at 1% or less and have no type of outlet structure. The pipe has an estimated maximum capacity of 71.9 cfs based on the assumed 1% slope and no backwater effects.

Subbasin G3 – Field investigation did not identify any storm drainage system in this basin. It is believed storm runoff from this basin flows directly into Dexter Lake.

Sub-basin G4 – Field investigation did not identify any storm drainage system in this basin. It is believed storm runoff from this basin flows directly into Dexter Lake.

Present Problems

Subbasin G1 – At the intersection of Everly Street and East Main Street, substantial ponding occurs in the roadway and should be addressed. There is a system of ditches and culverts that extend along East Main Street which appear to drain to an existing area drain that was partially clogged at the time of field observations. This area drain should be cleaned and maintained to prevent ponding.

Subbasin G2 – There are no known capacity problems in this basin. The 36” pipe along Moss Street is adequate for the drainage of this basin, however the possible pipe break should be investigated and repaired. Additionally, use of an underwater camera is recommended to determine the condition of the outfall.

Subbasin G3 – There are no known problems in this basin. All storm water appears to drain directly to Dexter Lake.

Subbasin G4 – There are no known problems in this basin. All storm water appears to drain directly to Dexter Lake.

Future System

Subbasin G1 – The majority of this basin is already built to capacity. There are a few available residential lots where development could occur, but this should have a very minimal impact on the existing storm drainage system.

Subbasin G2 – The majority of this basin is already built to capacity. There is a small portion of downtown commercial property where development could occur, but this should have a very minimal impact on the existing storm drainage system.

Subbasin G3 – The majority of this basin is already built to capacity. There are a few available residential lots where development could occur, but this should have a very minimal impact on the existing storm drainage system.

Subbasin G4 – The majority of this basin is already built to capacity. There are a few available residential lots where development could occur, but this should have a very minimal impact on the existing storm drainage system.



TC - G1 (25-yr)

LENGTH	TYPE	SLOPE	TIME
300	OVERLAND	0.15	25.3
818	DITCH	0.03	3.3
250	18" PIPE	0.06	0.3
TC (MINUTES)			28.9

TC - G2 (25-yr)

LENGTH	TYPE	SLOPE	TIME
300	OVERLAND	0.01	39.3
180	SHALLOW	0.01	5.5
681	PIPE	0.07	1.7
TC (MINUTES)			46.5

TC - G3 (25-yr)

LENGTH	TYPE	SLOPE	TIME
300	OVERLAND	0.01	2.6
160	SHALLOW	0.03	2.4
153	SHALLOW	0.09	0.5
131	SHALLOW	0.16	1.1
TC (MINUTES)			6.6

TC - G4 (25-yr)

LENGTH	TYPE	SLOPE	TIME
300	OVERLAND	0.07	13.9
348	SHALLOW	0.11	1.1
TC (MINUTES)			15.0

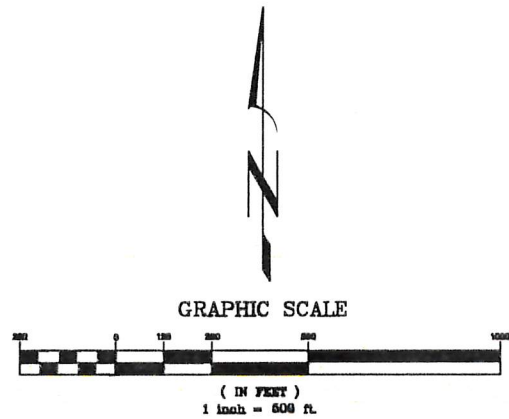

Stormwater Master Plan

Chapter 7



7.0 Basis of Planning

All planning and recommendations must be founded on established and accepted principals, methodologies, and regulations. This section serves to establish the methods and principals that will be utilized to prepare and analyze improvement alternatives as well as make final recommendations for improvements.

7.1 *Design Criteria*

Design criteria for future stormwater conveyance system expansions are based on existing topography, acreage within the basin, projected flows from future development within the basin, and estimated peak flows based on the design storm. Sizing of facilities will be based on the anticipated build-out conditions within each storm drainage basin to ensure that the conveyance system has adequate capacity for estimated peak flows.

General design considerations incorporated into the development of alternatives and, ultimately, the final recommendations are discussed below.

7.1.1 *Design Period*

The design period for projected flows is 20 years. Flow projections will be based on a 20 year population projection. All sizing recommendations will be based on this 20 year planning period.

Currently the City is requesting an increase to the adopted population growth rate from 2.22% to 4.62%. At the direction of City officials the 4.62% growth rate was utilized in this report for projected population projections. The projected populations were used to calculate the projected EDU's in each basin.

7.1.2 *Storm Drain & Culvert Design*

Stormwater conveyance systems should be designed considering natural ground slope, subsurface conditions, capacity requirements, minimum slope requirements, and minimum flow velocities necessary to maintain solids suspension. Whenever possible, gravity stormwater conveyance systems should be utilized to avoid the need for stormwater pump stations.

Stormwater conveyance systems should be designed to convey the projected flows from a basin, including development that may occur within a basin during the planning period. This will ensure that the stormwater piping will be adequate for the planning period including future development.

The minimum diameter of storm drains is generally 10-inches. Smaller pipes are difficult to clean and maintain using commonly available cleaning, TV-inspection, and repair equipment. Pipe diameter sizing should be based on anticipated flows established in the Stormwater Master Plan, rather than minimum slope considerations.

Manholes should be spaced no more than 450 feet apart and be a minimum of 48" in diameter for storm drains up to 24-inches in diameter. For mainlines greater than 24-inches in diameter or where a change of flow direction occurs, larger diameter manholes will be required. Manholes should also be constructed where alignment, slope, or pipe size changes occur. To facilitate self cleaning, an elevation drop should

occur within the channel across the manhole base. Flow channels in manholes should include a minimum 0.2-foot drop when the flow is straight through the manhole. If a manhole is constructed with a channel where the flow direction changes by 90-degrees with piping of the same size, the channel should include a base with a drop of 0.4-feet between the inlet and outlet pipes. Where manholes join pipes of more than one size, all incoming pipes should be elevated such that the point 0.8 times the diameter above the invert of the incoming pipe is equal to or higher than the point 0.8 times the diameter above the invert of the largest (exiting) pipe. See Figure 7-1 below for clarity.

Figure 7-1: Storm Drain Pipe Elevation Details

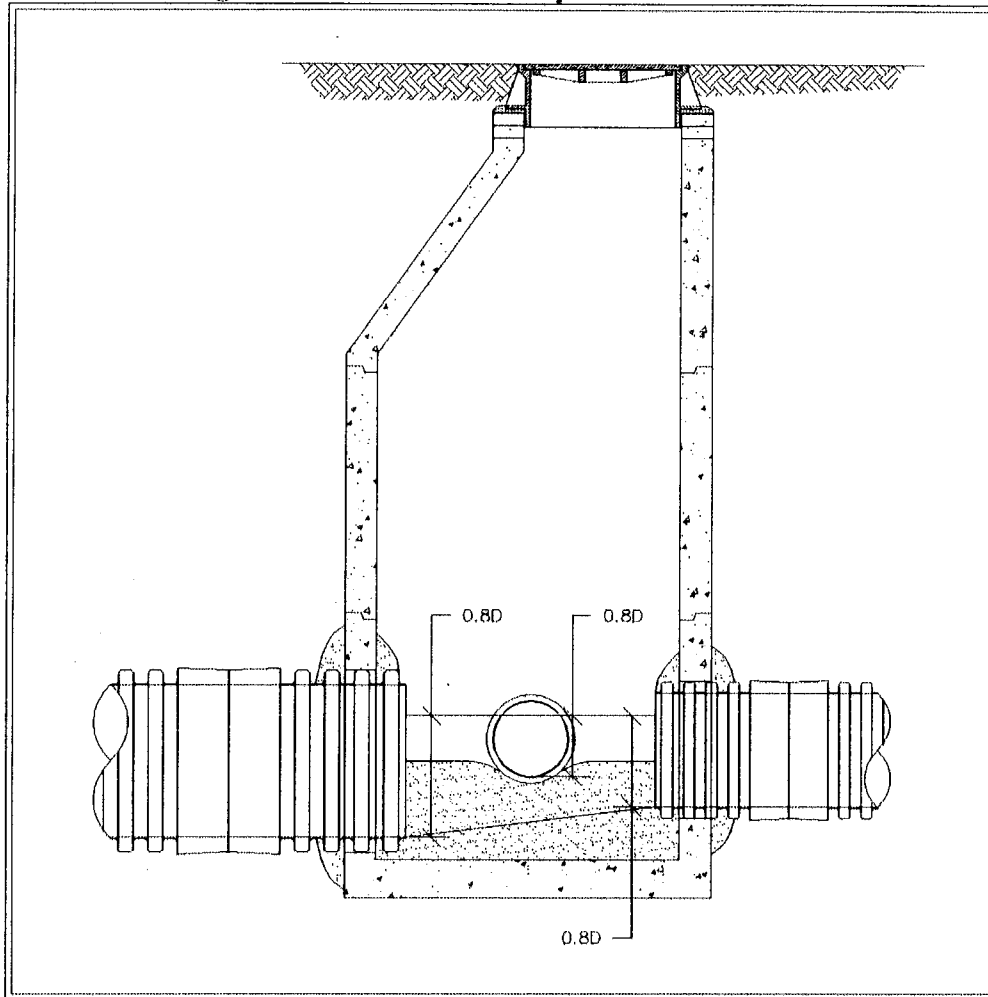

Manholes should have a minimum inside diameter of 48-inches at the bottom and have a standard 23-inch manhole access opening and lid. Manholes located in areas where flooding is expected should have bolt down lids to prevent lids from being lifted by rising water.

Flat top manholes should be utilized for all manhole installations under 6-feet deep. Otherwise, standard eccentric cone type manholes should be used. New manholes in Lowell should not be provided with integrated ladders in the manhole sections.

Minimum pipe slopes are established to ensure that flow velocities are high enough to provide a self-cleaning action for the stormwater conveyance piping. Current conventional design practice recommends that a minimum velocity of two feet per second (fps) be achieved regardless of pipe size to maintain self-

cleaning. It is desirable to have a velocity of 3 fps or more whenever topography and existing conditions allow. Minimum pipe slope for small diameter laterals should be 2-percent or ¼-inch drop per foot.

Standard methods of determining the slope for self-cleaning velocities are based on pipes flowing at least half-full. Where flows are expected to be less than half-full and adequate grade (topography) exists, a slope should be used that will provide velocities of 3 fps for full or half-full pipes. In general, minimum pipe slopes should be established based on the information in Table 7-1.

Table 7-1: Recommended Slopes for Storm Drains (ft/ft)
(Based on a Manning's 'n' of 0.013)

Nominal Pipe Diameter (in)	Minimum Slope (2 fps)	Recommended Slope (3 fps)
10	0.0025	0.0055
12	0.0019	0.0044
15	0.0014	0.0032
18	0.0011	0.0025
21	0.0009	0.0021
24	0.0008	0.0017
27	0.0007	0.0015
30	0.0006	0.0013
36	0.0004	0.0010
42	0.0004	0.0008
48	0.0003	0.0007
60	0.0002	0.0005

While the information in the table above provides the theoretical slopes to attain 2 fps or 3 fps for various pipe sizes, it is not usually considered practical to construct a gravity pipeline at a slope less than 0.2%; therefore pipes should generally be laid at a minimum 0.2% slope.

7.1.3 Storm Drain Pipe Materials

Traditional materials used in manufacturing pipe and conduits such as vitrified clay, concrete and steel are being increasingly replaced by pipes made from plastics, which are lighter weight, less expensive, more resistant to corrosion, and have superior flow characteristics. Plastic pipes used for municipal infrastructure improvements are predominantly made from polyethylene (PE) or polyvinyl chloride (PVC). Double walled high density polyethylene (HDPE) pipes, having a corrugated exterior and smooth interior, are commonly used in municipal stormwater applications. These pipes offer superior strength and corrosion resistance compared to corrugated metal pipe (CMP) products, and improved hydraulic performance when compared to both CMP and concrete.

Smooth walled rigid plastic pipe (HDPE or PVC) is frequently used to line existing conduits, such as CMP culverts. Although the insertion of a liner within an existing pipe decreases the internal diameter of the conduit, additional capacity is often achieved due to the improved hydraulic performance of the plastic pipe. Therefore, it is frequently desirable to line existing pipes with rigid plastic liners prior to structural failure of the existing pipe. Significant cost savings can be achieved by lining rather than removing and replacing existing pipes.

It is generally stated by plastic pipe manufacturers that a service life of 50 years or more can be expected with plastic pipe. In Technical Release TR-43/2003 "Design Service Life of Corrugated HDPE Pipe"

published by the Plastics Pipe Institute states: "There is considerable supporting justification for assuming a 100-year or greater design service life for corrugated polyethylene pipe, when properly used and reasonably well installed." The publication describes case studies on corrugated polyethylene pipe measuring tensile strength, elasticity, chemical resistance, and abrasion resistance that support the conclusion quoted above. It is also clear in bulletins published by the American Concrete Pipe Association that HDPE storm drain pipe must be properly installed in order to achieve a long service life. The ACPA has recorded numerous cases where HDPE storm drain pipes have failed or deflected significantly within a few years of installation.

For most of the projects within the City of Lowell it is expected that double walled HDPE storm drain piping will be preferred due to the relatively low installation costs and good performance characteristics. For projects where pipe lining can be utilized, smooth wall seamless HDPE or PVC pipe is recommended.

7.2 Basis for Cost Estimate

The construction cost estimates presented in this Plan will include a number of basic components; each of which is discussed in the following sections. The estimates presented are preliminary and based on the level of detail and planning presented in the Master Plan. As projects proceed and as site specific and new information becomes available, the estimates should be reviewed and updated.

7.2.1 Construction Costs

Construction costs are estimated using a combination of the following: engineering experience with similar past projects, material cost data provided by equipment suppliers, and material and labor cost estimates and indexes published by such sources as the Engineering News Record (ENR).

Whenever possible, existing as-built drawings were studied to determine the scope of work required for constructing and implementing improvements to existing facilities. When appropriate, preliminary layouts were developed and utilized when preparing construction cost estimates.

Future changes in the cost of labor, equipment and materials will require changes in the cost estimates provided in this Plan. For this reason, common engineering practice is to tie planning cost estimates to a construction cost index which is updated regularly in response to changes in the economy and the construction marketplace.

The Engineering News Record (ENR) construction cost index is the most common index used for engineering planning and estimating purposes. The ENR index is based on a beginning value of 100 established in the year 1913. Average yearly values for the past 18 years are summarized in Table 7-2.

Table 7-2: Index 1990 to 2008

YEAR	INDEX	% CHANGE/YR
1990	4732	2.54
1991	4835	2.18
1992	4985	3.10
1993	5210	4.51
1994	5408	3.80
1995	5471	1.16
1996	5620	2.72
1997	5826	3.67
1998	5920	1.61
1999	6059	2.35
2000	6221	2.67
2001	6343	1.96
2002	6538	3.07
2003	6694	2.39
2004	7115	6.29
2005	7446	4.65
2006	7751	4.10
2007	7967	2.78
September 2008	8557	7.41
Average Annual Change =		3.31

Cost estimates prepared in this plan are based on the September 2008 index. Future costs should be compared to a baseline ENR Index value of 8,557.

7.2.2 Contingencies

Contingencies are a prudent inclusion in planning cost estimates to account for unforeseen circumstances that may increase costs. For the purposes of this planning document and the preliminary cost estimates provided, a contingency amount between 15 and 25 percent of the estimated construction cost is used depending on the available information, number of unknowns, and other potential unknown factors that could affect the final project costs. After design work is completed for a project and updated construction cost estimates are completed, contingency is typically reduced to 10% for estimates used immediately prior to construction.

While efforts have been made to provide costs for all facets of the proposed projects, it is appropriate that allowances be made for variations in the final design, bidding market conditions, adverse construction conditions, unanticipated specialized investigation and studies, and other difficulties which cannot be foreseen at this time but may tend to increase the final costs of the proposed projects.

7.2.3 Engineering

The cost of engineering services for major capital improvement projects typically include surveying, foundation explorations, preparation of contract documents and project drawings, development of construction and material specifications, bidding services, construction management, inspection, construction staking, start up services, and the preparation of operation and maintenance manuals.

Depending on the size and type of the project and the required scope of engineering services, engineering costs are typically in the range of 18 to 25 percent.

In some cases, additional engineering or technical services may be required such as flow studies, pre-design reports, environmental reports or others. These additional services would typically be in addition to the regular engineering services covering surveying, design, bidding, construction management, and construction inspection.

For the purposes of conservative planning, the cost estimates prepared in this Master Plan assume that all projects will require a relatively comprehensive and complete scope of engineering services. Therefore, an engineering cost of 20% is assumed for nearly all projects. Smaller projects and projects of great complexity typically require larger engineering fees.

7.2.4 Legal and Administrative

Legal and administrative costs include such items as legal counsel review of contracts and contract documents, costs related to obtaining and recording easements and permits, additional city administration expenses occurring during a project, and other miscellaneous legal and administrative costs.

This cost category also includes potential costs for internal budget planning, grant administration, liaison costs, interest on interim loans financing, and other non-construction costs related to the projects.

A cost equal to 3% of the estimated construction cost is used for the estimates in this Plan.

7.2.5 Land Acquisition Costs

Some projects will require the acquisition of land for placement of new piping, pump stations, or other system components when available property is not available on an existing site or within an existing public right-of-way. In some cases, a property owner will require reimbursement for providing an easement across his/her property.

An effort was made in the plan to anticipate and identify which projects would require land or easement acquisition. For these projects, costs have been included for the purchase of additional properties for the improvements.

Property costs can vary depending on location, market volatility, owner's willingness to sell, and many other factors. In some cases, the City may have to condemn property when an owner is unwilling to sell and no alternative site is available. The condemnation process has significant costs associated with it and should be considered an option of last resort.

When a project is undertaken, the City should review the potential need for land acquisition. If it is determined that additional land is required, the costs for the acquisition of that land should be reviewed and updated based on real estate market values at the time.

7.2.6 Other Studies and Special Investigations

In some cases, pre-design reports, environmental reports, special flow studies, and other investigations may be required prior to beginning actual design activities for a project. These studies may be driven by funding or regulatory agencies or by special needs of a specific project.

An effort has been made to identify projects where these special studies will most likely be required. However, the need for these investigations and studies will be confirmed on a case by case basis throughout the planning period.

7.3 Regulatory Criteria

Planning, design, and construction of stormwater facilities must take into consideration all applicable regulatory criteria. The 1972 amendments to the Federal Water Pollution Control Act (known as the Clean Water Act or CWA) provide the statutory basis for the NPDES permit program and the basic structure for regulating the discharge of pollutants from point sources to waters of the United States. Section 402 of the CWA specifically required EPA to develop and implement the NPDES program. The CWA gives EPA the authority to set effluent limits on an industry-wide (technology-based) basis and on a water-quality basis that ensure protection of the receiving water. The CWA requires anyone who wants to discharge pollutants to first obtain an NPDES permit prior to discharge.

In response to the 1987 Amendments to the Clean Water Act (CWA), the U.S. Environmental Protection Agency (EPA) developed Phase I of the NPDES Stormwater Program in 1990. The Phase I program addressed sources of stormwater runoff that had the greatest potential to negatively impact water quality. Under Phase I, EPA required NPDES permit coverage for stormwater discharges from:

- Medium and large municipal separate storm sewer systems (MS4s) located in incorporated places or counties with populations of 100,000 or more;
- Eleven categories of industrial activity including construction activity that disturbs five or more acres of land

Operators of the systems, facilities, and construction sites regulated under the Phase I NPDES Stormwater Program must obtain permit coverage for the stormwater discharge from each site.

The Phase II Final Rule, published in the Federal Register on December 8, 1999, requires NPDES permit coverage for stormwater discharges from:

- Certain regulated small municipal separate storm sewer systems (MS4s); and
- Construction activity disturbing between 1 and 5 acres of land (i.e., small construction activities).

The regulated small municipal separate storm sewer systems (MS4s) are defined as any municipality within an urbanized area, and all municipalities of 10,000 people or more outside of any urbanized area. An urbanized area is defined as a land area that has a residential population of at least 50,000 and an overall population density of at least 1000 people per square mile. Because Lowell is not within an Urbanized Area, and since the current population is under 1000 people it is assumed the phase II rules will apply to the City.

The City should establish stormwater infrastructure standards for sizing and design of future developments. These standards would apply to both public and private development and would provide private developers a reliable guidance pertaining to stormwater facilities.

A sample Drainage System Design Standards Manual has been provided in the Appendix to this Master Plan for the City to use as a basis for establishing a stormwater manual for developers and their engineers. The design manual includes all information and guidelines required for a land developer to meet typical regulatory requirements and ensure that an appropriate level of effort has gone into planning and design of stormwater facilities.

7.4 Water Quality Issues

Stormwater runoff often contains materials that may degrade the quality of the waterways that the runoff enters and may harm stream ecology. These potentially harmful materials include sediments, organics, nutrients, and metals. In addition, runoff from impervious surfaces contributes to higher peak flows and warmer stream temperatures.

Turbidity from storm runoff can harm stream ecology in a number of ways. It can reduce light penetration and photosynthesis, hinder fish respiration, and reduce visibility, which affects their ability to find food. Additionally, the deposition of solid materials on the stream bottom can harm benthic (bottom-dwelling) organisms and their habitat. The amount and form of solids contained in a stormwater sample are measured in laboratory tests for total solids (TS), total suspended solids (TSS), and total dissolved solids (TDS).

Organic materials are a concern because they can affect the amount of dissolved oxygen available in the water column for fish and other aquatic organisms which use dissolved oxygen for respiration. A reduction in dissolved oxygen occurs as the organic materials are naturally biodegraded by stream bacteria that utilize the organic material as a food source and the oxygen for respiration during metabolism. The amount of organic materials contained in stormwater runoff is measured in laboratory tests for biochemical oxygen demand (BOD) and chemical oxygen demand (COD).

Nutrients such as nitrogen and phosphorus are a concern because their presence can lead to excessive algae growth as well as undesirable fluctuations in pH and dissolved oxygen resulting in toxicity and nuisance conditions. Under some environmental conditions, algae can grow rapidly to nuisance levels if a growth-limiting nutrient is provided in sufficient concentrations. Nitrogen compounds are generally measured as total Kjeldahl nitrogen (TKN), ammonia (NH_3), and nitrite plus nitrate (NO_{2+3}). Phosphorus compounds are generally measured as total phosphorus (TP), soluble phosphorus (SP), and ortho-phosphorus (OP).

The concentrations of certain metals in stormwater discharge are typically limited by a Total Maximum Daily Load (TMDL) established by the EPA or other regulatory agency. High concentrations of metals are cause of concern because if they are present in significant concentrations, they can be toxic to aquatic organisms and tend to bio-accumulate in natural systems. Metals of significant interest include lead (Pb), copper (Cu), and zinc (Zn).

The quantity of stormwater runoff plays a major factor in the water quality of rivers and streams. When natural groundcover is replaced by impervious surfaces such as buildings and pavement, rainfall is forced to runoff into the storm drainage system rather than percolating into the soil. This causes higher peak flow rates immediately following storms, which can in turn increase stream bank erosion under certain discharge conditions. The reduction of groundwater recharge contributes to lower base stream flow in the dry summer months. This reduction in base stream flows tends to have a detrimental effect on riparian habitat.

Water temperature in streams and rivers are monitored and several streams and rivers are listed as temperature limited by the EPA and Oregon DEQ. A small increase in a stream's temperature can greatly impact its ecology. Higher temperatures reduce the amount of dissolved oxygen available for fish and other aquatic life. Threatened species such as salmon and cutthroat trout spawn in cold-water streams. In urban areas, runoff is warmed from surfaces such as rooftops and pavement. Removal of vegetation on streambeds also allows sunlight to warm streams directly.

In 1983, the EPA initiated the National Urban Runoff Program (NURP). During the course of their study, they evaluated the chemical characteristics of stormwater runoff for a number of different areas by land use category. The chemical characteristics of stormwater vary considerably depending on the nature of the runoff surface, as shown in Table 7-3. It is noted that residential land use has the largest median concentrations of pollutants listed.

Table 7-3: Median Runoff Concentration by Land Use Category

Parameter (mg/L)	Land Use Category			
	Residential	Commercial	Mixed	Open/Non-urban
BOD	10.0	9.3	7.8	---
COD	73.0	57.0	65.0	40.0
TSS	101.0	69.0	67.0	70.0
Pb	0.144	0.140	0.114	0.030
Cu	0.033	0.029	0.027	---
Zn	0.135	0.226	0.254	0.195
TKN	1.90	1.18	1.29	0.965
NO ₂₊₃	0.736	0.572	0.558	0.543
TP	0.383	0.201	0.263	0.121
SP	0.143	0.080	0.056	0.026

Source: National Urban Runoff Program as reported in Stahre and Urbonas (1990).

Abbreviations:

BOD	Biochemical Oxygen Demand
COD	Chemical Oxygen Demand
Cu	Copper
Mg/L	Milligrams per Litre
NO ₂₊₃	Nitrite plus Nitrate
Pb	Lead
SP	Soluble Phosphorus
TP	Total Phosphorus
TSS	Total Suspended Solids
TKN	Total Kjeldahl Nitrogen
Zn	Zinc

7.5 TMDL Implementation

Currently the City of Lowell is preparing a Total Maximum Daily Load (TMDL) implementation plan. The federal Clean Water Act, Oregon Administrative Rule 340-042-0030, and the water pollutant load allocations for the Middle Fork subbasin require designated management agencies such as the City of Lowell to reduce the temperature, bacteria, and general pollutants in the Middle Fork subbasin of the

Willamette River. The City's TMDL implementation plan will address the adequacy of current discharge practices as well as establishing future discharge policy.

The city proposed meeting the temperature TMDL by decreasing solar radiation inputs. This includes protecting and enhancing riparian areas by encouraging riparian vegetation growth. There are a series of drainage swales particularly mentioned in the Stormwater Master Plan that called for an increase in riparian vegetation and shading, including the 4th Street drainage (See outfall D1), the 3rd Street drainage (See outfall D2), the Eastern Drainage downstream of East 1st Street (See culvert E3-C), and the relocation and rehabilitation of the Western Drainage along Basins D and B. It is important that these areas be improved and maintained in the future.

It is mentioned in the report that there are no water bodies in the Middle Fork on the 303 (d) list for Bacteria, however the City has chosen to help reduce their bacterial pollutants. Besides meeting their current NPDES permit for wastewater discharge, the City has provided pet/animal waste stations to help reduce animal waste from entering water bodies. They are also enforcing DEQ 1200-C permits, ensuring that all developments greater than one acre obtain and comply with permit requirements to reduce sediment discharge.

This Stormwater Master Plan also aids in limiting the future introduction of bacteria and other pollutants into water bodies by providing new storm drain system design standards which incorporate water quality standards to future development. These include sump style catch basins, which help trap sediment prior to discharge, and water quality manholes immediately upstream of any direct discharge into a water body or wetland. A system map also has been provided for the City, indicating where water quality protection would best be utilized, and identified projects to enhance the water quality. It also recommends the introduction of a storm utility fee to help pay for maintenance of the storm drainage system and water quality features, including maintenance of vegetation along waterways, sediment removal from catch basins and WQ manholes, and keeping ditches and culverts clear of garbage and debris.

The City has also teamed with the Lane County Solid Waste Management to provide annual hazardous waste events to provide easy and convenient means for proper disposal of hazardous chemicals or other substances. The City is considering adding information on their webpage along with other outreach programs to inform people how to keep pollutants out of waterways.

Stormwater Master Plan

Chapter 8



8.0 Development and Evaluation of Projects

8.1 Storm Drain System Piping Projects

Storm drain system projects have been developed to address existing capacity deficiencies, maintenance needs, and future development capacity requirements. Alternatives, recommendations, and specific project costs are discussed below for each basin.

8.1.1 Basin A

Project A1 – Although this basin is relatively undeveloped at this time with little storm drainage infrastructure, two of the existing culverts are inadequately sized for future growth. The 18” corrugated culvert (Culvert A1-C) under Moss Street approximately 130 feet north of Seneca Street is undersized for the calculated present and future flows based on the 25-year storm. Although the piping is undersized, it has not been reported to be a problem in terms of causing flooding on streets or private property. It is likely that the storm drain surcharges during periods of heavy rainfall but not to the extent that significant flooding occurs. Furthermore, this storm drain is located in an undeveloped area. If surcharging does occur, it is unlikely that it would be noticed. In order to provide capacity for the calculated future flows a 24” smooth wall (i.e. HDPE double wall or PVC) pipe at a minimum 2% slope is recommended. It is further recommended that additional study be completed at the time of development of any contributing areas east of Moss Street to ensure the recommended pipe sizing is adequate.

A cost estimate for project A1 is provided below:

Table 8.1.1 – Storm Drain System Project A1

Item No.	Description	Units	Quantity	Unit Cost	Total Cost
1	Bonds, Insurance, Overhead, Mobilization Costs	ls	1	\$1,600.00	\$1,600.00
2	24” HDPE Storm Drain Piping	lf	80	\$130.00	\$10,400.00
3	AC Pavement Repair/Trench Patching	ton	8	\$125.00	\$1,000.00
Construction Total					\$13,000.00
Contingency (20%)					\$2,600.00
Subtotal					\$15,600.00
Engineering (20%)					\$3,120.00
Administrative Costs (3%)					\$468.00
Total Project Cost					\$19,188.00

Project A2 – The 24” CMP culvert under 7th Street approximately 380 feet westerly of Moss Street is adequately sized for calculated future flows. This pipe should be replaced with a minimum 24” smooth wall pipe at 2% slope, or a pipe of equivalent capacity. This pipe also should be studied in greater detail depending on the level of development planned upstream.

A cost estimate for project A2 is provided below:

Table 8.1.2 – Storm Drain System Project A2

Item No.	Description	Units	Quantity	Unit Cost	Total Cost
1	Bonds, Insurance, Overhead, Mobilization Costs	ls	1	\$1,600.00	\$1,600.00
2	24” HDPE Storm Drain Piping	lf	80	\$130.00	\$10,400.00
3	Gravel Surfacing	cy	10	\$50.00	\$500.00
Construction Total					\$12,500.00
Contingency (20%)					\$2,500.00
Subtotal					\$15,000.00
Engineering (20%)					\$3,000.00
Administrative Costs (3%)					\$450.00
Total Project Cost					\$18,450.00

8.1.2 Basin B

No specific storm drain piping deficiencies were identified or projects developed for Basin B.

8.1.3 Basin C

Project C1 – The existing storm 36” CMP culvert (Culvert C1-C) under Moss Street at 6th Street is undersized for the calculated peak runoff generated by the 25-year design storm based on predicted 20-year and buildout development conditions. Currently most of this basin is drained with the use of ditches and driveway culverts which will be inadequate as development continues. The presence of large open ditches and unprotected culvert inlets present a public safety hazard, especially in residential areas where children will be present. It is recommended that the main ditch along 6th Street, the 36” CMP culvert (Culvert C1-C) under Moss Street, and the parallel 24” HDPE culverts (Culvert C2-C) west of Moss Street be replaced with a continuous 36” HDPE trunk storm drain extending east to the intersection of D Street. A total of 460 lineal feet of 36” HDPE pipe will be required for the proposed improvements. As additional development occurs this trunk line would need to be extended and sized accordingly.

The 36” and parallel 24” pipes are adequate for the calculated existing flows, but as development occurs and flows increase, the pipe capacity will be exceeded. All existing pipes and ditches that flow into the pipe must be connected to the new system with manholes, ditch inlets, and catch basins or curb inlets constructed at appropriate locations.

A cost estimate for project C1 is provided below:

Table 8.1.3 – Storm Drain System Project C1

Item No.	Description	Units	Quantity	Unit Cost	Total Cost
1	Bonds, Insurance, Overhead, Mobilization Costs	ls		\$12,500.00	\$12,500.00
2	36" HDPE Storm Drain Piping	lf	460	\$180.00	\$82,800.00
3	Manhole (60" Diameter)	ea	2	\$4,000.00	\$8,000.00
4	Ditch Inlet	ea	2	\$1,800.00	\$3,600.00
5	Catch Basin	ea	2	\$1,800.00	\$3,600.00
6	AC Pavement Repair/Trench Patching	ton	12	\$125.00	\$1,500.00
Construction Total					\$112,000.00
Contingency (20%)					\$22,400.00
Subtotal					\$134,400.00
Engineering (20%)					\$26,880.00
Administrative Costs (3%)					\$4,032.00
Total Project Cost					\$165,312.00

Project C2 – The 24" corrugated metal pipe (Culvert C3-C) which crosses Moss Street at the intersection of 7th Street currently discharges stormwater onto private property at higher flows. There is a shallow ditch along the westerly shoulder of Moss Street which contains low water flows, but as flows increase the ditch is unable to contain the water. The pipe has sufficient capacity for the calculated current and future peak flows. Therefore it is recommended that the flooding problem be solved by installing some form of outlet protection to redirect flows exiting the culvert, and the ditch be modified to increase its capacity. As development within the contributing area increases, construction of storm drain piping along Moss Street should be considered to connect this area to the 36" trunk line described in project C1.

A cost estimate for project C2 is provided below:

Table 8.1.4 – Storm Drain System Project C2

Item No.	Description	Units	Quantity	Unit Cost	Total Cost
1	Bonds, Insurance, Overhead, Mobilization Costs	ls	1	\$1,000.00	\$1,000.00
2	Outlet Protection	ls	1	\$1,500.00	\$1,500.00
3	Enlarge Existing Ditch	lf	600	\$20.00	\$12,000.00
Construction Total					\$14,500.00
Contingency (20%)					\$2,900.00
Subtotal					\$17,400.00
Engineering (20%)					\$3,480.00
Administrative Costs (3%)					\$522.00
Total Project Cost					\$21,402.00

8.1.4 Basin D

Project D1 – In addition to providing stormwater capacity improvements for calculated future peak flows, the City of Lowell desires to improve its level of water quality. A common method of enhancing water quality within open drainage courses is to add and maintain appropriate vegetation for shade and filtering. Water quality improvements are suggested along the existing drainage swale that lies between the parallel 60” pipes (Outfall D1) at Moss Street and 4th Street and the five 24” culverts (Culvert D1-C) that lie approximately 120 feet to the west. Although this swale has adequate grass to provide filtering it has no protection from the sun. Therefore, it is recommended that some trees native to the area be planted along the swale to provide shade. The NRCS Soil Survey of Lane County indicates that Oregon ash and Oregon white oak naturally occur in the Pengra silt loam soil that is present at this location. It is assumed that this swale is within a drainage easement and there is an agreement for its maintenance. If not that should be addressed prior to proceeding with the suggested improvements. No engineering is expected to be required for this project, however, surveying may be required to establish a drainage easement if not already present.

A cost estimate for project D1 is provided below:

Table 8.1.5 – Storm Drain System Project D1

Item No.	Description	Units	Quantity	Unit Cost	Total Cost
1	Purchase and Plant Trees	Is	1	\$5,000.00	\$5,000.00
	Contingency (20%)				\$1,000.00
	Subtotal				\$6,000.00
	Survey/Record Easement (If Req'd)				\$2,500.00
	Administrative Costs (3%)				\$200.00
	Total Project Cost				\$8,700.00

Project D2 – There is an existing concrete culvert under D Street north of 4th Street for which an outlet can not be identified. The pipe should be TV'd or die tested to find out if it where it discharges. Once it has been determined where the pipe discharges it should be properly mapped. This project may need to be expanded depending on the results of the video.

A cost estimate for project D2 is provided below:

Table 8.1.6 – Storm Drain System Project D2

Item No.	Description	Units	Quantity	Unit Cost	Total Cost
1	Storm Drain Piping Video Inspection	If	100	\$5.00	\$500.00
	Construction Total				\$500.00
	Contingency (20%)				\$100.00
	Subtotal				\$600.00
	Administrative Costs (3%)				\$100.00
	Total Project Cost				\$700.00

Project D3 – Outfall D2 is believed to consist of a pair of 12” concrete pipes that cross Moss Street at the intersection of 3rd Street. The condition of the pipes is uncertain as they discharge into an overgrown drainage swale and were not accessed for inspection. It is recommended that the swale be cleaned of blackberry vines to improve hydraulic conditions and facilitate access to the pipes. The drainage swale crosses private property and it is uncertain whether or not a drainage easement exists. If not, one should be obtained prior to any maintenance or improvements in this area. In addition to cleaning the swale, it is recommended that the pipes be replaced with two 18” smooth walled pipes at 2% slope, or equivalent, in order to provide adequate capacity for the calculated future peak flows at this point.

A cost estimate for project D3 is provided below:

Table 8.1.7 – Storm Drain System Project D3

Item No.	Description	Units	Quantity	Unit Cost	Total Cost
1	Bonds, Insurance, Overhead, Mobilization Costs	ls	1	\$4,450.00	\$4,450.00
2	18” HDPE Storm drain piping	lf	140	\$120.00	\$16,800.00
3	Connect to Existing Manhole	ea	2	\$1,000.00	\$2,000.00
4	AC Pavement Repair/Trench Patching	ton	14	\$125.00	\$1,750.00
5	Clear & Shape Drainage Swale	lf	400	\$25.00	\$10,000.00
6	Restoration & Replanting	ls	1	\$2,000.00	\$2,000.00
Construction Total					\$37,000.00
Contingency (20%)					\$7,400.00
Subtotal					\$44,400.00
Engineering (20%)					\$8,880.00
Administrative Costs (3%)					\$1,332.00
Total Project Cost					\$54,612.00

Project D4 – Paul Fisher Park has what appears to be a storm drainage pipe that discharges onto the park. This pipe should be extended and connected to the storm drainage system along Moss Street. There is an existing area drain located just north of 3rd Street to which the pipe can be connected; the subject storm drainage system appears to have adequate capacity.

A cost estimate for project D4 is provided below:

Table 8.1.8 – Storm Drain System Project D4

Item No.	Description	Units	Quantity	Unit Cost	Total Cost
1	Bonds, Insurance, Overhead, Mobilization Costs	ls	1	\$3,000.00	\$3,000.00
2	Area Drain	ea	1	\$1,500.00	\$1,500.00
3	12” HDPE Storm Drain Piping	lf	150	\$110.00	\$16,500.00
4	Connect to Existing Area Drain	ea	1	\$1,000.00	\$1,000.00
Construction Total					\$22,000.00
Contingency (20%)					\$4,400.00
Subtotal					\$26,400.00
Engineering (20%)					\$5,280.00
Administrative Costs (3%)					\$792.00
Total Project Cost					\$32,472.00

8.1.5 Basin E

Project E1 – The majority of the drainage within this basin is channelized within the Eastern Drainage. A portion of the stream flows between existing residences along East 1st Street. At the crossing of East 1st Street, the stream passes through a 30” CMP culvert (Culvert E3-C) where it is then discharged between two homes on the south side of the street. The stream continues south across several other residential lots. The subject culvert is undersized for the calculated current and future peak flows. Additionally, there has been reported flooding on lots south of East 1st Street and adjacent to the stream during larger storm events. In order to improve drainage and eliminate flooding of the lots, it is suggested that the existing culvert be replaced and rerouted to an undeveloped public alleyway located on the south side of East 1st Street approximately 220 feet east of Hyland Drive. In the alley, an appropriately sized drainage swale or additional storm drainage piping should be constructed. For the purposes of estimation, it is assumed that an open drainage swale will be constructed within the alley and new 36” HDPE storm drainage piping will be constructed from the existing culvert inlet to the north end of the alley.

A cost estimate for project E1 is provided below:

Table 8.1.9 – Storm Drain System Project E1

Item No.	Description	Units	Quantity	Unit Cost	Total Cost
1	Bonds, Insurance, Overhead, Mobilization Costs	ls	1	\$11,200.00	\$11,200.00
2	36" HDPE Storm Drain Piping	lf	250	\$180.00	\$45,000.00
3	Manhole (60" Diameter)	ea	2	\$4,000.00	\$8,000.00
4	Ditch Inlet	ea	1	\$1,800.00	\$1,800.00
5	Construct New Swale	lf	450	\$30.00	\$13,500.00
6	Restoration & Replanting	ls	1	\$2,500.00	\$2,500.00
7	AC Pavement Repair/Trench Patching	ton	32	\$125.00	\$4,000.00
Construction Total					\$86,000.00
Contingency (20%)					\$17,200.00
Subtotal					\$103,200.00
Engineering (20%)					\$20,640.00
Environmental/Permitting					\$15,000.00
Administrative Costs (3%)					\$3,096.00
Total Project Cost					\$141,936.00

Project E2 – In addition to the improvements suggested above, if there is not an easement upstream of the existing culvert at the crossing of the Eastern Drainage and East 1st Street, one should be obtained. A budget of at least \$2,500 is suggested for surveying and recording easement descriptions. As the upper portion of Basin E is developed, easements and buffers will be required for the drainage. These should be incorporated into future development plans at no cost to the City.

8.1.6 Basin F

No specific storm drain piping deficiencies were identified or projects developed for Basin B.

8.1.7 Basin G

Project G1 – At the intersection of Everly Street and East Main Street there is an existing low point which does not drain and causes large puddles within the roadway. The water becomes several inches deep and is in an area with curbs and sidewalk. To correct the drainage problem, curb inlets should be installed along with storm drain piping to direct drainage to nearby storm drain piping. There are two routes available for the planned piping; either connecting to the existing storm drainage system within Loftus Avenue, or connecting to the 36” pipe within Moss Street. The route selected depends on the size/condition of piping within Lotus Avenue and the condition of the 36” pipe in Moss Street. Neither is known at this time (in fact those questions are identified later within this section).

A cost estimate for project G1 is provided below:

Table 8.1.10 – Storm Drain System Project G1

Item No.	Description	Units	Quantity	Unit Cost	Total Cost
1	Bonds, Insurance, Overhead, Mobilization Costs	ls	1	\$8,000.00	\$8,000.00
2	Curb Inlets	ea	2	\$1,500.00	\$3,000.00
3	12" HDPE Storm Drain Piping	lf	350	\$100.00	\$35,000.00
4	Manhole (48" Diameter)	ea	4	\$3,000.00	\$12,000.00
5	Connect to Existing Manhole	ea	1	\$1,000.00	\$1,000.00
6	AC Pavement Repair/Trench Patching	ton	40	\$125.00	\$5,000.00
Construction Total					\$64,000.00
Contingency (20%)					\$12,800.00
Subtotal					\$76,800.00
Engineering (20%)					\$15,360.00
Administrative Costs (3%)					\$2,304.00
Total Project Cost					\$94,464.00

Project G2 – There are three catch basins within Loftus Ave that drain to the west between several residences. The subject pipe makes several turns and drains through another catch basin located in Alder Street before discharging into Dexter Lake (Outfall G1). There are no as-builts of this system, and because it crosses residential lots and includes a submerged outlet we were unable to inspect portions of this pipe or identify the outfall. It is recommended that a TV inspection be completed to determine the condition of the submerged outfall. If there is no easement for the subject pipe, one should be obtained to allow future maintenance.

A cost estimate for project G2 is provided below:

Table 8.1.11 – Storm Drain System Project G2

Item No.	Description	Units	Quantity	Unit Cost	Total Cost
1	Storm Drain Piping Video Inspection	lf	600	\$5.00	\$3,000.00
Construction Total					\$3,000.00
Contingency (20%)					\$600.00
Subtotal					\$3,600.00
Administrative Costs (3%)					\$100.00
Total Project Cost					\$3,700.00

Project G3 – There is a 36” storm pipe within Moss Street south of Pengra Road which outfalls to Dexter Lake (Outfall G2). There are reports of this pipe needing repair near the wastewater treatment plant, by the gate. It is recommended that a TV inspection be completed for this section of pipe and the outfall in order to identify the extent of damage and determine the condition of the submerged outfall. Because the damage could not be identified, this project may need to be expanded after more information is gathered.

A cost estimate for project G3 is provided below:

Table 8.1.12 – Storm Drain System Project G3

Item No.	Description	Units	Quantity	Unit Cost	Total Cost
1	Storm Drain Piping Video Inspection	If	300	\$5.00	\$1,500.00
2	Repair 36" Pipe	Is	1	10,000.00	\$10,000.00
Construction Total					\$11,500.00
Contingency (20%)					\$2,300.00
Subtotal					\$13,800.00
Engineering (20%)					\$2,760.00
Administrative Costs (3%)					\$414.00
Total Project Cost					\$16,974.00

8.1.8 Western Drainage

Basins A, B, C, and D all drain into the Western Drainage, which meanders through the western portion of the City. The creek is generally located on private property and passes through numerous culverts and adjacent to residences before making its way into Dexter Lake. Easements and/or open space should be obtained along this drainage to allow the City to protect, maintain and enhance the creek. There are portions of the drainage where it comes within 20’ of existing homes. These homes have very little protection from flooding. When easements and/or open space are obtained, consideration should be given to relocating the drainage away from existing homes where applicable.

A cost estimate for the improvements to the Western Drainage is provided below:

Table 8.1.13 – Western Drainage Improvements

Item No.	Description	Units	Quantity	Unit Cost	Total Cost
1	Bonds, Insurance, Overhead, Mobilization Costs	Is	1	\$12,000.00	\$12,000.00
2	Drainage Rehabilitation	Is	1	\$20,000.00	\$20,000.00
3	Drainage Relocation	If	2,000	\$30.00	\$60,000.00
Construction Total					\$92,000.00
Contingency (20%)					\$18,400.00
Subtotal					\$110,400.00
Engineering (20%)					\$22,080.00
Environmental & Permitting					\$15,000.00
Land Aquisition					\$35,000.00
Administrative Costs (3%)					\$3,312.00
Total Project Cost					\$185,792.00

8.1.9 TMDL Implementation

The City recently completed a plan to implement a TMDL strategy to reduce pollutants in the Middle Fork Willamette Basin. Several of the projects recommended herein help reach the goals of this plan by including water quality enhancement elements. However, the plan calls for future monitoring, education and testing. Although this is not an actual construction project, it is meant as a general fund the City can utilize to implement the plan and should be included when establishing a storm water utility fund.

A cost estimate for the TMDL Implementation plan is provided below:

Table 8.1.14 – Storm Drain System Project TMDL

Item No.	Description	Units		Quantity	Unit Cost	Total Cost
		Is				
1	TMDL Implementation	Is		1	\$10,000.00	\$10,000.00
Total Project Cost						\$10,000.00

8.2 Cleaning and Televising

As discussed in the previous section, a number of projects were developed to televise specific sections that have been identified as potential maintenance problems, or due to a lack of information. Because no specific information was available as to the state of existing problems, no specific projects could be developed for these piping sections at this time.

For the piping sections identified, it is recommended that they be thoroughly cleaned and televised to allow for a careful engineering evaluation and development of projects to correct any existing deficiencies.

This work can be completed using City equipment and operations staff or by entering into a contract with a cleaning and televising contractor.

All television inspection tapes should be provided to the City Engineer for review. Deficiencies should be noted and catalogued for potential improvement projects. Serious deficiencies should be corrected immediately.

8.3 Storm Drain System Management and Maintenance

Many of the maintenance activities recommended below are currently practiced by City Staff. However, we recommend the City consider developing a more formalized maintenance program and schedule based on the approach outlined below. This approach consists of a preventative maintenance program, routine maintenance program, and a program for responding to emergency spills.

8.3.1 Preventative Maintenance

Preventative maintenance consists of all measures taken to prevent conditions from developing which would reduce the storm water system's ability to function properly. As noted above, many of these maintenance activities are currently being completed by the public works staff, or are subcontracted out.

Maintenance tasks for a preventative program would include:

- Street Cleaning
- Leaf Removal
- Garbage pick-up
- Hazardous waste collection
- Erosion Control
- Mowing/Removal of invasive plants in ditches and swales

The streets that have the most traffic should be cleaned most often because they collect greater amounts of sediment, debris, and other problem materials and pollutants. A City leaf removal program will reduce the potential for storm sewer blockage and subsequent flooding caused by leaf debris. Adequate garbage pick-up should be provided to ensure that refuse is not washing down storm drains. A municipally sponsored hazardous waste program would give citizens the opportunity to drop off household wastes, such as motor oil, paint, pesticides, and herbicides, for proper disposal. Erosion Control measures can be required by the City for all construction projects as a condition of obtaining a building permit. The City should help enforce the 1200-C requirements for all construction disturbances of more than 1-acre by not granting any City permits until 1200-C permits are obtained. Mowing and removing invasive plants from the City's swales and ditches are important maintaining hydraulic capacity. Since there are numerous ditches in town it is important they be kept clean and free flowing.

8.3.2 Routine Maintenance

Routine Maintenance consists of practices that are completed at regular intervals to ensure satisfactory performance of the storm water system. Specific tasks to be included in a routine maintenance program are discussed below.

Drainage channels should be maintained by removing debris and other materials that significantly impede storm water flow. Excessive sediment should also be removed and disposed of in a manner that will prevent future transport. Attention should be paid to controlling erosion in channels by maintaining vegetation and provide channel protection such as rip-rap, where necessary.

Pipes and culverts should be cleaned by flushing them with water, pulling a cleaning "pie" through them, or removing obstructions with a hand tool. The conditions of pipes should be reviewed periodically by visual inspection and by using television equipment.

Manholes and catch basins should be inspected routinely. Where necessary, excess sediment should be removed. They should also be used to inspect entrance and exit pipes for sediment build-up or structural failures. Inlet grates should be cleaned by removing all built up sediment and debris.

A maintenance activity schedule contains a listing of suggested activities and a schedule of frequency for each. It is intended to be used as a general guide by City staff in developing a more specific maintenance schedule for the City as staffing and funding allows. It should also be mentioned that many of these items have already been identified and put into action with the Lowell TMDL plan.

Table 8.1.15 – Maintenance Schedule

Maintenance Operation	Suggested Frequency					
	Weekly	Monthly	Quarterly	Bi-annually	Annually	As Needed
Preventative						
Street Cleaning				X		
Leaf Removal					X	
Garbage Pick-up					X	
Hazardous Waste Collection					X	
Erosion Control						X
Ditch/Swale Maintenance					X	
Routine Maintenance						
Channels					X	
Pipes/Culverts					X	
Manholes					X	
Catch basins / Inlets				X		

8.4 Documentation and Recordkeeping

Documentation and recordkeeping is an important component in the operation and maintenance of the storm drain system. This includes maintaining up-to-date maps of the system, storing as-built drawings of existing components, keeping a maintenance log of when and where maintenance tasks are performed, and documenting problems in the system as they occur.

A large map of the existing storm sewer system in Lowell has been provided with this plan. City staff should update this map as new construction occurs and as field observations identify new or corrective information. It should also be updated as televised pipe data becomes available. As-built drawings for new construction should be kept in conjunction with the storm sewer map to provide additional detail in those specific locations.

The City should keep a log of all maintenance tasks performed. The log would include the date, location, components maintained, time required to do maintenance, quantity of sediment or other materials removed, and space for additional comments.

Documentation of drainage problems occurring in the system should include both photographs and written statements. Photographs should show any problems that exist at the time, with particular attention given to erosion and flooding. The photographs should be dated and properly located on a sketch map of the area. Written statements indicating the problem or describing the conditions during a flood should be dated and properly signed by the person(s) making the observations. Additional information should include high-water elevations, flood profiles, estimated flow velocity, direction of flow, and sketched maps showing the extent of flooding. Also, any corrective actions, if any, should be noted. Detailed field documentation is crucial in cases of property damage and in preparation of any claims or litigation that may result.

Stormwater Master Plan

Chapter 9

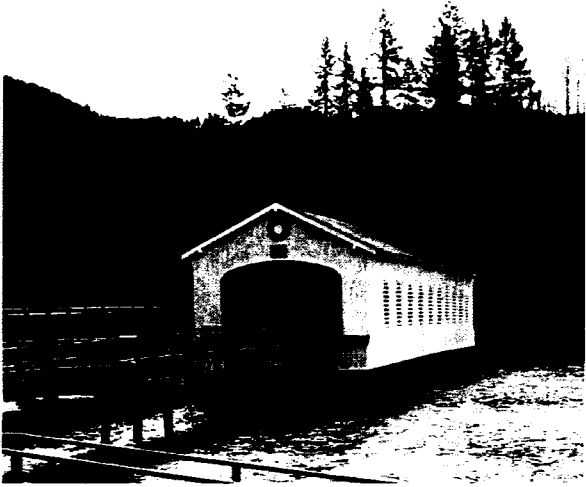

9.0 Recommended Plan

9.1 *Introduction*

This Stormwater Master Plan has identified a number of capacity deficiencies and potential maintenance issues in the storm drain piping network owned and maintained by the City of Lowell. To address these deficiencies, improvement projects have been developed that will correct, repair, replace, or upgrade system components that are currently deficient or are projected to be deficient within the planning period.

Cost estimates have been prepared for each project, including potential costs for design, construction, contingency, and project administration. The projects and their associated costs make up the basis for the recommended plan that the City of Lowell is to follow throughout the planning period.

Determination of which projects are to be undertaken and the order in which they are undertaken is dependent on a number of variables. New development, system failures, priority maintenance issues, and other factors will drive the selection of projects during the planning period.

The purpose of this Chapter of the Master Plan is to provide the City with a “starting place” for which to begin their stormwater planning. This Section will provide a summary of the developed projects, present a proposed prioritization for the projects, and undertake a discussion on the implementation of the recommended plan.

It is understood that the prioritization and schedule developed in this Plan will be subject to change based on the variables discussed above. The City should develop and maintain a dynamic and functional Capital Improvement Plan (CIP) that includes the highest priority projects developed in this Plan.

It is very possible that a project that is not currently considered a high priority can become one due to a catastrophic system failure or unanticipated development pressure. In this case, the City must react and reprioritize projects accordingly.

It is also possible that system components that have not been identified as deficient during the planning period will become deficient, necessitating an improvement project. In these cases, the City must develop projects to correct previously unknown or unexpected deficiencies and add projects to the CIP and the project priority list.

9.2 Project Cost Summary

Projects were developed throughout the City's stormwater drainage system and in many of the basins to correct existing deficiencies, address maintenance issues, and/or to provide for future system capacity.

The projects developed in Chapter 8 for storm drain piping improvements are summarized in Table 9-1.

Table 9-1: Storm Drain System Improvement Project Summary

Project Number	Project Name (Description)	% SDC Eligible	SDC Eligible Cost	Total Project Cost
A1	18" Culvert Replacement, Moss Street north of Seneca	50%	\$9,594.00	\$19,188.00
A2	24" Culvert Replacement, 7 th Street west of Moss Street	100%	\$18,450.00	\$18,450.00
C1	36" Culvert Replacement, Moss Street at 6 th Street	100%	\$165,312.00	\$165,312.00
C2	24" Culvert Outlet & Ditch Improvements, Moss Street	0%	\$0.00	\$21,402.00
D1	Tree Planting, 4 th Street Swale west of Moss Street	0%	\$0.00	\$8,700.00
D2	TV Inspection, D Street north of 4 th Street	0%	\$0.00	\$700.00
D3	3 rd Street Outfall and Swale Enhancement	50%	\$27,306.00	\$54,612.00
D4	Paul Fisher Park Pipe Extension	0%	\$0.00	\$32,472.00
E1	Eastern Drainage – Pipe Improvements & Relocation	75%	\$106,452.00	\$141,936.00
G1	Everly Street Drainage Improvements	0%	\$0.00	\$94,464.00
G2	TV Inspection, Loftus Street Storm Drain	0%	\$0.00	\$3,700.00
G3	TV Inspection and Repair, Moss Street Storm Drain	0%	\$0.00	\$16,974.00
WD	Western Drainage Easement/Rehab/Relocation	75%	\$139,344.00	\$185,792.00
TMDL	TMDL Implementation Plan		\$0.00	\$10,000.00

Total Costs: \$466,458.00 \$773,702.00

In addition to the projects summarized above, other recommendations were made in Chapter 8 including the development of a maintenance and inventory database system and systematic television inspection program to locate problem areas. While these programs have costs associated with them, specific budgets were not developed as part of the CIP (Capital Improvement Plan). For planning purposes, a minimum annual budget of \$6,000 is suggested for inventory and inspection of existing storm drain piping along with general maintenance.

9.3 Project Prioritization

It is difficult to rate piping projects with a priority status. When considering prioritizing piping projects, the following should be considered:

1. Is there a deficiency that could result in a total failure of the piping section?
2. The length of time the deficiency has caused problems for the City and for residents.
3. Availability and source of funding.
4. Coordination of project with other improvements (water, sewer, streets, etc).
5. Development pressures requiring the upsizing of pipe to increase capacity.

With these inputs in mind, the following priority summary was prepared for the storm drain system improvement projects:

Table 9-2: Storm Drain System Project Prioritization Summary

	Priority Rating	Project Number	Project Name (Description)	Total Project Cost
A	1	TMDL	TMDL Implementation Plan	\$10,000.00
	2	G1	Everly Street Drainage Improvements	\$94,464.00
	3	WD	Western Drainage Easement/Rehab/Relocation	\$185,792.00
	4	E1	Eastern Drainage – Pipe Improvements & Relocation	\$141,936.00
	5	C2	24" Culvert Outlet & Ditch Improvements, Moss Street	\$21,402.00
B	6	D3	3 rd Street Outfall and Swale Enhancement	\$54,612.00
	7	D1	Tree Planting, 4 th Street Swale west of Moss Street	\$8,700.00
	8	D4	Paul Fisher Park Pipe Extension	\$32,472.00
	9	G2	TV Inspection, Loftus Street Storm Drain	\$3,700.00
	10	G3	TV Inspection and Repair, Moss Street Storm Drain	\$16,974.00
	11	D2	TV Inspection, D Street north of 4 th Street	\$700.00
C	12	C1	36" Culvert Replacement, Moss Street at 6 th Street	\$165,312.00
	13	A1	18" Culvert Replacement, Moss Street north of Seneca	\$19,188.00
	14	A2	24" Culvert Replacement, 7 th Street west of Moss Street	\$18,450.00
			Total	\$773,702.00

9.4 Implementation Plan

Implementation of a plan to repair or replace piping sections and initiate new maintenance and management practices in the City's storm drainage system represents a complicated and costly decision for the City of Lowell.

It may be considered presumptuous for a Master Plan to develop a schedule or direct a City to undertake projects in a particular order or on a specific timeline. However, it is appropriate to provide some "broad strokes" with regard to the findings and recommendations in the plan and point the City in the proper general direction.

This section will attempt to discuss a potential schedule and discuss financing if the City undertakes the high priority projects recommended in the plan.

9.4.1 Schedule

While many have attempted to provide rigid schedules in master planning efforts, they are almost never followed in practice. Budget processes, seasonal issues, depressions, and other issues change the proposed schedule from almost the first day. It is, perhaps, more important to identify the highest priority projects and recommend that the City undertake those projects as soon as funding is available.

In Section 9.3 projects were ranked and listed in order of priority. While the content and project prioritization previously presented may be argued, the list will provide the City with a starting place when considering what projects to place on their capital improvement list and in what order those projects should be undertaken.

Table 9.3 identifies three separate project groups, A, B, and C, which are roughly defined as follows:

Group A: These are the highest priority projects that should be undertaken as soon as adequate funding is available. It should be considered that these projects should be undertaken within the next 5 years with highest projects on the list to be addressed in the next year or two.

Group B: These projects, while not of the highest priority, should be on the City's capital improvement planning window beyond the 5-year horizon. As Group A projects are completed, Group B projects should be moved to Group A status. System degradation or failures, project coordination, or other occurrence may require the movement of Group B projects to Group A status ahead of schedule. New projects that are developed that are not critical, should be grouped in Group B until funding is available.

Group C: Group C projects are either of low priority or are dependent on development. If development in an area necessitates the implementation of a Group C improvement, the project should be moved to Group A status assuming that adequate funding is available to undertake it. Some projects may remain in Group C indefinitely if the need for the project or the development requiring it never arises.

Based on these definitions the Group A projects are priority projects that should be undertaken as soon as funding is available. And as stated previously, it is recommended that all Group A projects be completed within the next 5 years. All other projects are dependent upon funding, the completion of Group A

projects, or development pressures. The City should maintain a “living” capital improvement list and project schedule based on these general guidelines.

9.4.2 Potential Financing Options

The City will soon be considering undertaking numerous storm drain system improvement projects. The overall cost of these projects will be thousands of dollars.

Unlike projects involving water or wastewater system improvements, funding assistance is not typically available for storm drain system improvements since public health is not at stake. Non-grant funding includes bonds, loans, system development charges (SDC's), capital construction funds (sinking funds), local improvement districts, and others.

Loans and bonds will be available to the City with interest rates on the order of 5 percent depending on the status of the federal prime rates, the length of the payback term, the source of revenue used to payback the funds (user rates, general fund taxes, etc.), and other variables.

The City should not obtain loans with payback terms longer than the design life of the improvements that are being constructed. Piping materials commonly used today have expected useful lives significantly longer than that of products commonly used in the past. Because of this, loans with terms of 20 years, or slightly more, are acceptable for storm drain system improvements.

The City of Lowell does not presently have a specific user fee for storm drain system maintenance that is charged to rate payers. It was determined from meetings with the city that funds from the transportation fund were used to cover storm drain system projects as necessary. In order to appropriately fund the storm drain system improvement projects identified herein it is recommended that the City modify its rate structure to include a separate storm drain maintenance and improvement category. Any of several different methods could be used to determine usage fees for each rate payer. It is recommended for simplicity that charges be determined on an Equivalent Dwelling Unit (EDU) basis as introduced in Sections 3.4.2 and 3.4.3. Under the described system, each single family dwelling would be charged an equal rate for one EDU. Commercial and industrial customers would be charged a rate for a number of EDU's calculated based on the amount of impermeable surface present on the site. In this way, customers having larger areas of impermeable surface, and which generate greater volumes of runoff, would be responsible for a greater portion of system maintenance and improvement fees. Because the storm drain projects recommended herein will require significant capital for construction and repayment of loans or bonds, it is recommended that the City determine a basic rate structure sufficient to cover all existing maintenance costs prior to considering the improvement projects. Once baseline user fees have been determined, fee increases, as discussed in the following section, to cover the cost of the recommended improvements can be applied.

9.4.3 Potential Impacts to Rate Payers

The impact to rate payers will depend on the projects that the City undertakes, the schedule that they follow, and the rate structure that is established. The priority projects developed in this plan are summarized below:

Table 9.3 – Project Prioritization Summary

Priority	Description	Total
A	Group A - High Priority Projects	\$453,594.00
B	Group B - Lower Priority Projects	\$117,158.00
C	Group C - Low Priority and Development Dependent Projects	\$202,950.00

Total \$773,702.00

To provide a glimpse into a conservative impact to rate payers, the following scenarios are provided:

Scenario 1: It is assumed that the City will undertake all the projects in the Priority A group for a total project cost of \$453,594.00. Because the projects will be primarily maintenance based, and in some cases capacity building to serve areas that are already developed, the projects are only partially SDC eligible if at all. Based on these factors, the total cost impact to rate payers will be entirely based on a funding source that requires payback (loan, bond, etc.). Even though a portion of the SDC fees collected can be used to pay back for projects already completed, that still doesn't effect the amount the City would need to borrow and payback on until those funds are collected. Therefore, it is assumed the entire project cost would need to be financed by the City and later refunded.

Principal: \$453,594.00
 Interest Rate: 5% per year
 Term: 20 years (240 months)
 Monthly Payment: \$2,981.10
 EDU's: 498

Based on these terms, the rate needed per EDU required to pay back a loan of the indicated principal amount is approximately \$5.99 per month.

Scenario 2: In this scenario, it is assumed that the City will aggressively pursue the proposed projects by obtaining funding to complete both Priority A and Priority B groups. Under this more aggressive approach, the following impact to ratepayers applies:

Principal: \$570,752.00
 Interest Rate: 5% per year
 Term: 20-years (240 months)
 Monthly Payment: \$3,751.08
 EDU's: 498

Based on these terms, the rate needed per EDU required to pay back a loan of the indicated principal amount is approximately \$7.53 per month. Given that the projects in Group B are rather small in nature and don't create much of an increase, funding for those projects should be strongly considered.

The final rate increases established by the City must consider all the variables discussed above. Creating a storm utility rate is a difficult step for any community to make. However, the City is responsible to maintain the existing storm drainage system and increase system capacity where development has been

allowed to occur upstream of insufficiently sized facilities. Adequate funding must be raised to finance repairs of a constantly degrading infrastructure, promote development where land is available, and overcome inflation. These increases will inevitably require raising user rates within the City of Lowell. It should be noted that the above scenarios do not include maintenance, inventory or an annual inspection program. They only show moneys needed to pay back loans for projected improvements to the City's infrastructure.

Scenario 3: In this scenario, it is assumed that the City will aggressively pursue the proposed projects by obtaining funding to complete both Priority A and Priority B groups. Under this more aggressive approach, the following impact to ratepayers applies:

Principal: \$570,752.00
Interest Rate: 5% per year
Term: 20-years (240 months)
Monthly Payment: \$3,751.08
EDU's: 498

Based on these terms, the rate needed per EDU required to pay back a loan of the indicated principal amount is approximately \$7.53 per month. However that does not include the approximate \$6,000 annual budget to maintain and inventory the existing system. That increases the monthly amount needed to be collected by \$500.00 to \$4,251.08. Based on the same number of EDU's, that would result in a storm water utility fee of \$8.54 per month.

Stormwater Master Plan

Appendix A



Data for LOWELL BASINS A - D, EXISTING

Page 4

TYPE IA 24-HOUR RAINFALL= 4.25 IN

Prepared by HBH Consulting Engineers, Inc.

14 Oct 08

HydroCAD 5.11 001354 (c) 1986-1999 Applied Microcomputer Systems

SUBCATCHMENT 4

BASIN D1 - EXISTING

PEAK= 45.28 CFS @ 8.41 HRS, VOLUME= 13.00 AF

ACRES	CN		SCS TR-20 METHOD
17.00	87	1/4 ACRE RES. - GROUP D SOIL	TYPE IA 24-HOUR
11.10	82	2 ACRE RES. - GROUP D SOIL	RAINFALL= 4.25 IN
25.70	79	FOREST - GROUP D SOIL	SPAN= 5-15 HRS, dt=.05 HRS
3.40	84	URBAN, FAIR COND. - GROUP D SOIL	
33.00	79	RES. UNDEVELOPED - GROUP D SOIL	
2.10	80	URBAN, GOOD COND. - GROUP D SOIL	
19.70	72	FOREST - GROUP C SOIL	
6.10	79	RES. CONSTRAINED - GROUP D SOIL	
118.10	79		

Method	Comment	Tc (min)
TR-55 SHEET FLOW	SHEET FLOW	15.7
Woods: Light underbrush	n=.4 L=300' P2=3.5 in s=.35 '/'	
SHALLOW CONCENTRATED/UPLAND FLOW	SHALLOW CONCENTRATED - SEGMENT 1	6.4
Woodland Kv=5 L=1372' s=.5138 '/' V=3.58 fps		
SHALLOW CONCENTRATED/UPLAND FLOW	SHALLOW CONCENTRATED - SEGMENT 2	19.7
Woodland Kv=5 L=2544' s=.1847 '/' V=2.15 fps		
CHANNEL FLOW	NATURAL CHANNEL	1.5
a=7.5 sq-ft Pw=7.2' r=1.042'		
s=.0839 '/' n=.04 V=11.06 fps L=977' Capacity=82.9 cfs		
CIRCULAR CHANNEL	CULVERT	1.2
30" Diameter a=4.91 sq-ft Pw=7.9' r=.625'		
s=.0347 '/' n=.011 V=18.4 fps L=1324' Capacity=90.3 cfs		
Total Length= 6517 ft		Total Tc= 44.5



SUBCATCHMENT 4

BASIN D1 - 20 YEAR

PEAK= 52.80 CFS @ 8.39 HRS, VOLUME= 14.92 AF

ACRES	CN		SCS TR-20 METHOD
50.00	87	1/4 ACRE RES. - GROUP D SOIL	TYPE IA 24-HOUR
11.10	82	2 ACRE RES. - GROUP D SOIL	RAINFALL= 4.25 IN
25.70	79	FOREST - GROUP D SOIL	SPAN= 5-15 HRS, dt=.05 HRS
3.40	92	MULTI-FAMILY RES. - GROUP D SOIL	
2.10	80	URBAN, GOOD COND. - GROUP D SOIL	
19.70	72	FOREST - GROUP C SOIL	
6.10	79	DEVELOPMENT CONSTRAINED - GRP. D	
118.10	82		

Method	Comment	Tc (min)
TR-55 SHEET FLOW	SHEET FLOW	15.7
Woods: Light underbrush n=.4 L=300' P2=3.5 in s=.35 '/'		
SHALLOW CONCENTRATED/UPLAND FLOW	SHALLOW CONCENTRATED - SEGMENT 1	6.4
Woodland Kv=5 L=1372' s=.5138 '/' V=3.58 fps		
SHALLOW CONCENTRATED/UPLAND FLOW	SHALLOW CONCENTRATED - SEGMENT 2	19.7
Woodland Kv=5 L=2544' s=.1847 '/' V=2.15 fps		
CHANNEL FLOW	NATURAL CHANNEL	1.5
a=7.5 sq-ft Pw=7.2' r=1.042'		
s=.0839 '/' n=.04 V=11.06 fps L=977' Capacity=82.9 cfs		
CIRCULAR CHANNEL	CULVERT	1.2
30" Diameter a=4.91 sq-ft Pw=7.9' r=.625'		
s=.0347 '/' n=.011 V=18.4 fps L=1324' Capacity=90.3 cfs		
Total Length= 6517 ft		Total Tc= 44.5

SUBCATCHMENT 4 RUNOFF PEAK= 52.80 CFS @ 8.39 HOURS

HOUR	0.00	.05	.10	.15	.20	.25	.30	.35	.40	.45
5.00	1.86	2.00	2.15	2.30	2.45	2.61	2.78	2.95	3.12	3.31
5.50	3.49	3.68	3.87	4.07	4.26	4.46	4.65	4.85	5.05	5.25
6.00	5.45	5.66	5.87	6.09	6.32	6.57	6.82	7.10	7.38	7.68
6.50	7.98	8.29	8.59	8.90	9.19	9.47	9.73	9.98	10.19	10.41
7.00	10.61	10.84	11.05	11.31	11.57	11.88	12.21	12.60	13.02	13.50
7.50	14.02	14.63	15.34	16.27	17.46	19.02	21.00	23.49	26.46	29.80
8.00	33.40	37.11	40.77	44.21	47.22	49.73	51.52	52.56	52.80	52.42
8.50	51.48	50.15	48.48	46.67	44.76	42.87	41.06	39.43	37.97	36.65
9.00	35.46	34.36	33.35	32.40	31.51	30.65	29.84	29.02	28.25	27.48
9.50	26.76	26.05	25.40	24.77	24.21	23.67	23.20	22.75	22.38	22.02
10.00	21.71	21.41	21.16	20.90	20.68	20.44	20.23	19.99	19.79	19.57
10.50	19.38	19.16	18.99	18.80	18.66	18.49	18.38	18.25	18.17	18.06
11.00	17.99	17.90	17.84	17.74	17.67	17.57	17.49	17.37	17.29	17.16
11.50	17.07	16.94	16.83	16.70	16.59	16.45	16.33	16.18	16.05	15.90
12.00	15.77	15.63	15.51	15.38	15.28	15.18	15.10	15.01	14.96	14.91
12.50	14.88	14.85	14.85	14.84	14.85	14.85	14.85	14.84	14.82	14.78
13.00	14.74	14.69	14.64	14.59	14.55	14.51	14.49	14.47	14.46	14.46



SUBCATCHMENT 4 BASIN D1 - BUILDOUT

PEAK= 52.80 CFS @ 8.39 HRS, VOLUME= 14.92 AF

ACRES	CN		SCS TR-20 METHOD
50.00	87	1/4 ACRE RES. - GROUP D SOIL	TYPE IA 24-HOUR
11.10	82	2 ACRE RES. - GROUP D SOIL	RAINFALL= 4.25 IN
25.70	79	FOREST - GROUP D SOIL	SPAN= 5-15 HRS, dt=.05 HRS
3.40	92	MULTI-FAMILY RES. - GROUP D SOIL	
2.10	80	URBAN, GOOD COND. - GROUP D SOIL	
19.70	72	FOREST - GROUP C SOIL	
6.10	79	DEVELOPMENT CONSTRAINED - GRP. D	
118.10	82		

Method	Comment	Tc (min)
TR-55 SHEET FLOW	SHEET FLOW	15.7
Woods: Light underbrush n=.4 L=300' P2=3.5 in s=.35 '/'		
SHALLOW CONCENTRATED/UPLAND FLOW	SHALLOW CONCENTRATED - SEGMENT 1	6.4
Woodland Kv=5 L=1372' s=.5138 '/' V=3.58 fps		
SHALLOW CONCENTRATED/UPLAND FLOW	SHALLOW CONCENTRATED - SEGMENT 2	19.7
Woodland Kv=5 L=2544' s=.1847 '/' V=2.15 fps		
CHANNEL FLOW	NATURAL CHANNEL	1.5
a=7.5 sq-ft Pw=7.2' r=1.042'		
s=.0839 '/' n=.04 V=11.06 fps L=977' Capacity=82.9 cfs		
CIRCULAR CHANNEL	CULVERT	1.2
30" Diameter a=4.91 sq-ft Pw=7.9' r=.625'		
s=.0347 '/' n=.011 V=18.4 fps L=1324' Capacity=90.3 cfs		
Total Length= 6517 ft		Total Tc= 44.5

SUBCATCHMENT 4 RUNOFF PEAK= 52.80 CFS @ 8.39 HOURS

HOUR	0.00	.05	.10	.15	.20	.25	.30	.35	.40	.45
5.00	1.86	2.00	2.15	2.30	2.45	2.61	2.78	2.95	3.12	3.31
5.50	3.49	3.68	3.87	4.07	4.26	4.46	4.65	4.85	5.05	5.25
6.00	5.45	5.66	5.87	6.09	6.32	6.57	6.82	7.10	7.38	7.68
6.50	7.98	8.29	8.59	8.90	9.19	9.47	9.73	9.98	10.19	10.41
7.00	10.61	10.84	11.05	11.31	11.57	11.88	12.21	12.60	13.02	13.50
7.50	14.02	14.63	15.34	16.27	17.46	19.02	21.00	23.49	26.46	29.80
8.00	33.40	37.11	40.77	44.21	47.22	49.73	51.52	52.56	52.80	52.42
8.50	51.48	50.15	48.48	46.67	44.76	42.87	41.06	39.43	37.97	36.65
9.00	35.46	34.36	33.35	32.40	31.51	30.65	29.84	29.02	28.25	27.48
9.50	26.76	26.05	25.40	24.77	24.21	23.67	23.20	22.75	22.38	22.02
10.00	21.71	21.41	21.16	20.90	20.68	20.44	20.23	19.99	19.79	19.57
10.50	19.38	19.16	18.99	18.80	18.66	18.49	18.38	18.25	18.17	18.06
11.00	17.99	17.90	17.84	17.74	17.67	17.57	17.49	17.37	17.29	17.16
11.50	17.07	16.94	16.83	16.70	16.59	16.45	16.33	16.18	16.05	15.90
12.00	15.77	15.63	15.51	15.38	15.28	15.18	15.10	15.01	14.96	14.91
12.50	14.88	14.85	14.85	14.84	14.85	14.85	14.85	14.84	14.82	14.78
13.00	14.74	14.69	14.64	14.59	14.55	14.51	14.49	14.47	14.46	14.46



Data for LOWELL BASINS A - D, EXISTING

TYPE IA 24-HOUR RAINFALL= 5.00 IN

Prepared by Civil West Engineering Services, Inc.

24 Sept 08

HydroCAD 5.11 001354 (c) 1986-1999 Applied Microcomputer Systems

SUBCATCHMENT 4

BASIN D1 - EXISTING

PEAK= 60.82 CFS @ 8.40 HRS, VOLUME= 17.22 AF

ACRES	CN		SCS TR-20 METHOD
17.00	87	1/4 ACRE RES. - GROUP D SOIL	TYPE IA 24-HOUR
11.10	82	2 ACRE RES. - GROUP D SOIL	RAINFALL= 5.00 IN
25.70	79	FOREST - GROUP D SOIL	SPAN= 5-15 HRS, dt=.05 HRS
3.40	84	URBAN, FAIR COND. - GROUP D SOIL	
33.00	79	RES. UNDEVELOPED - GROUP D SOIL	
2.10	80	URBAN, GOOD COND. - GROUP D SOIL	
19.70	72	FOREST - GROUP C SOIL	
6.10	79	RES. CONSTRAINED - GROUP D SOIL	
118.10	79		

Method	Comment	Tc (min)
TR-55 SHEET FLOW	SHEET FLOW	15.7
Woods: Light underbrush	n=.4 L=300' P2=3.5 in s=.35 '/'	
SHALLOW CONCENTRATED/UPLAND FLOW	SHALLOW CONCENTRATED - SEGMENT 1	6.4
Woodland Kv=5 L=1372' s=.5138 '/' V=3.58 fps		
SHALLOW CONCENTRATED/UPLAND FLOW	SHALLOW CONCENTRATED - SEGMENT 2	19.7
Woodland Kv=5 L=2544' s=.1847 '/' V=2.15 fps		
CHANNEL FLOW	NATURAL CHANNEL	1.5
a=7.5 sq-ft Pw=7.2' r=1.042'		
s=.0839 '/' n=.04 V=11.06 fps L=977' Capacity=82.9 cfs		
CIRCULAR CHANNEL	CULVERT	1.2
30" Diameter a=4.91 sq-ft Pw=7.9' r=.625'		
s=.0347 '/' n=.011 V=18.4 fps L=1324' Capacity=90.3 cfs		
Total Length= 6517 ft		Total Tc= 44.5



TYPE IA 24-HOUR RAINFALL= 5.00 IN

Prepared by Civil West Engineering Services, Inc.

24 Sept 08

HydroCAD 5.11 001354 (c) 1986-1999 Applied Microcomputer Systems

SUBCATCHMENT 3 BASIN C - 20 YEAR

PEAK= 59.66 CFS @ 8.55 HRS, VOLUME= 18.08 AF

ACRES	CN		SCS TR-20 METHOD
16.90	85	1/2 ACRE RES. - GROUP D SOIL	TYPE IA 24-HOUR
6.00	82	2 ACRE RES. - GROUP D SOIL	RAINFALL= 5.00 IN
36.00	87	1/4 ACRE RES. - GROUP D SOIL	SPAN= 5-15 HRS, dt=.05 HRS
2.00	79	UNDEVELOPED RES. - GROUP D SOIL	
2.30	93	PUBLIC (INDUSTRIAL) - GROUP D	
25.50	79	FOREST - GROUP D SOIL	
18.90	79	DEVELOPMENT CONSTRAINED - GRP. D	
107.60	83		

Method	Comment	Tc (min)
TR-55 SHEET FLOW	OVERLAND SHEET FLOW	40.3
Woods: Light underbrush n=.4 L=300' P2=3.5 in s=.0333 '/'		
SHALLOW CONCENTRATED/UPLAND FLOW	SHALLOW CONCENTRATED FLOW	11.2
Woodland Kv=5 L=1570' s=.2197 '/' V=2.34 fps		
CHANNEL FLOW	CHANNEL FLOW SEGMENT 1	1.8
a=3 sq-ft Pw=4.8' r=.625'		
s=.1366 '/' n=.04 V=10.04 fps L=1076' Capacity=30.1 cfs		
CHANNEL FLOW	CHANNEL FLOW SEGMENT 2	3.6
a=10 sq-ft Pw=9.7' r=1.031'		
s=.0385 '/' n=.05 V=5.95 fps L=1274' Capacity=59.5 cfs		
Total Length= 4220 ft		Total Tc= 56.9

SUBCATCHMENT 3 RUNOFF PEAK= 59.66 CFS @ 8.55 HOURS

HOUR	0.00	.05	.10	.15	.20	.25	.30	.35	.40	.45
5.00	3.50	3.67	3.85	4.02	4.21	4.40	4.59	4.79	4.99	5.20
5.50	5.42	5.63	5.86	6.09	6.32	6.55	6.78	7.03	7.26	7.50
6.00	7.74	7.97	8.23	8.47	8.73	9.00	9.27	9.56	9.86	10.18
6.50	10.51	10.84	11.19	11.53	11.87	12.22	12.54	12.87	13.17	13.46
7.00	13.75	14.00	14.28	14.55	14.82	15.13	15.44	15.80	16.18	16.60
7.50	17.08	17.60	18.25	19.03	19.98	21.19	22.66	24.51	26.72	29.32
8.00	32.29	35.57	39.04	42.55	46.03	49.36	52.31	54.90	57.00	58.45
8.50	59.43	59.66	59.46	58.85	57.73	56.45	54.88	53.22	51.54	49.78
9.00	48.16	46.58	45.09	43.72	42.38	41.18	40.00	38.86	37.82	36.76
9.50	35.79	34.82	33.87	33.01	32.12	31.34	30.57	29.84	29.20	28.56
10.00	28.01	27.50	27.00	26.58	26.14	25.76	25.41	25.04	24.74	24.40
10.50	24.10	23.81	23.50	23.25	22.97	22.72	22.49	22.25	22.07	21.87
11.00	21.70	21.55	21.38	21.26	21.12	20.99	20.88	20.73	20.63	20.49
11.50	20.35	20.24	20.08	19.95	19.80	19.65	19.51	19.34	19.20	19.04
12.00	18.87	18.73	18.55	18.41	18.26	18.11	17.99	17.86	17.75	17.65
12.50	17.55	17.49	17.42	17.37	17.34	17.29	17.28	17.24	17.21	17.19
13.00	17.14	17.11	17.05	17.00	16.96	16.90	16.87	16.82	16.78	16.76
13.50	16.71	16.70	16.67	16.64	16.63	16.58	16.56	16.51	16.46	16.43
14.00	16.36	16.32	16.26	16.19	16.15	16.08	16.04	15.99	15.94	15.91

14.50 | 15.86 15.84 15.81 15.77 15.76 15.72 15.70 15.69 15.65 15.64
15.00 | 15.61

TYPE IA 24-HOUR RAINFALL= 5.00 IN

Prepared by Civil West Engineering Services, Inc.

24 Sept 08

HydroCAD 5.11 001354 (c) 1986-1999 Applied Microcomputer Systems

SUBCATCHMENT 4 BASIN D1 - 20 YEAR

PEAK= 69.13 CFS @ 8.39 HRS, VOLUME= 19.34 AF

ACRES	CN		SCS TR-20 METHOD
50.00	87	1/4 ACRE RES. - GROUP D SOIL	TYPE IA 24-HOUR
11.10	82	2 ACRE RES. - GROUP D SOIL	RAINFALL= 5.00 IN
25.70	79	FOREST - GROUP D SOIL	SPAN= 5-15 HRS, dt=.05 HRS
3.40	92	MULTI-FAMILY RES. - GROUP D SOIL	
2.10	80	URBAN, GOOD COND. - GROUP D SOIL	
19.70	72	FOREST - GROUP C SOIL	
6.10	79	DEVELOPMENT CONSTRAINED - GRP. D	
118.10	82		

Method	Comment	Tc (min)
TR-55 SHEET FLOW	SHEET FLOW	15.7
Woods: Light underbrush n=.4 L=300' P2=3.5 in s=.35 '/'		
SHALLOW CONCENTRATED/UPLAND FLOW	SHALLOW CONCENTRATED - SEGMENT 1	6.4
Woodland Kv=5 L=1372' s=.5138 '/' V=3.58 fps		
SHALLOW CONCENTRATED/UPLAND FLOW	SHALLOW CONCENTRATED - SEGMENT 2	19.7
Woodland Kv=5 L=2544' s=.1847 '/' V=2.15 fps		
CHANNEL FLOW	NATURAL CHANNEL	1.5
a=7.5 sq-ft Pw=7.2' r=1.042'		
s=.0839 '/' n=.04 V=11.06 fps L=977' Capacity=82.9 cfs		
CIRCULAR CHANNEL	CULVERT	1.2
30" Diameter a=4.91 sq-ft Pw=7.9' r=.625'		
s=.0347 '/' n=.011 V=18.4 fps L=1324' Capacity=90.3 cfs		
Total Length= 6517 ft		Total Tc= 44.5

SUBCATCHMENT 4 RUNOFF PEAK= 69.13 CFS @ 8.39 HOURS

HOUR	0.00	.05	.10	.15	.20	.25	.30	.35	.40	.45
5.00	3.81	4.01	4.20	4.41	4.61	4.83	5.05	5.28	5.52	5.76
5.50	6.00	6.26	6.51	6.77	7.02	7.28	7.54	7.80	8.04	8.31
6.00	8.56	8.83	9.09	9.38	9.67	10.00	10.32	10.68	11.05	11.44
6.50	11.83	12.24	12.63	13.03	13.39	13.75	14.07	14.37	14.63	14.90
7.00	15.14	15.41	15.67	15.98	16.30	16.68	17.10	17.59	18.12	18.74
7.50	19.41	20.20	21.12	22.33	23.88	25.92	28.51	31.77	35.64	40.00
8.00	44.67	49.47	54.18	58.57	62.38	65.53	67.73	68.94	69.10	68.47
8.50	67.11	65.26	62.99	60.54	57.97	55.43	53.02	50.84	48.90	47.13
9.00	45.53	44.07	42.72	41.45	40.27	39.14	38.06	36.99	35.96	34.95
9.50	34.01	33.09	32.24	31.42	30.68	29.97	29.36	28.78	28.28	27.81
10.00	27.41	27.02	26.69	26.34	26.05	25.74	25.46	25.16	24.89	24.60
10.50	24.35	24.07	23.85	23.60	23.41	23.20	23.05	22.88	22.77	22.63
11.00	22.53	22.41	22.32	22.19	22.10	21.97	21.86	21.71	21.59	21.44
11.50	21.31	21.14	21.01	20.83	20.69	20.51	20.35	20.16	20.00	19.81
12.00	19.65	19.46	19.31	19.15	19.02	18.88	18.78	18.67	18.60	18.53
12.50	18.50	18.46	18.45	18.44	18.44	18.44	18.44	18.41	18.39	18.34
13.00	18.29	18.22	18.16	18.09	18.04	17.99	17.95	17.93	17.91	17.91

TYPE IA 24-HOUR RAINFALL= 5.00 IN

Prepared by Civil West Engineering Services, Inc.

24 Sept 08

HydroCAD 5.11 001354 (c) 1986-1999 Applied Microcomputer Systems

SUBCATCHMENT 3 BASIN C - BUILDOUT

PEAK= 59.66 CFS @ 8.55 HRS, VOLUME= 18.08 AF

ACRES	CN		SCS TR-20 METHOD
16.90	85	1/2 ACRE RES. - GROUP D SOIL	TYPE IA 24-HOUR
6.00	82	2 ACRE RES. - GROUP D SOIL	RAINFALL= 5.00 IN
38.00	87	1/4 ACRE RES. - GROUP D SOIL	SPAN= 5-15 HRS, dt=.05 HRS
2.30	93	PUBLIC (INDUSTRIAL) - GROUP D	
25.50	79	FOREST - GROUP D SOIL	
18.90	79	DEVELOPMENT CONSTRAINED - GRP. D	
107.60	83		

Method	Comment	Tc (min)
TR-55 SHEET FLOW	OVERLAND SHEET FLOW	40.3
Woods: Light underbrush n=.4 L=300' P2=3.5 in s=.0333 '/'		
SHALLOW CONCENTRATED/UPLAND FLOW	SHALLOW CONCENTRATED FLOW	11.2
Woodland Kv=5 L=1570' s=.2197 '/' V=2.34 fps		
CHANNEL FLOW	CHANNEL FLOW SEGMENT 1	1.8
a=3 sq-ft Pw=4.8' r=.625'		
s=.1366 '/' n=.04 V=10.04 fps L=1076' Capacity=30.1 cfs		
CHANNEL FLOW	CHANNEL FLOW SEGMENT 2	3.6
a=10 sq-ft Pw=9.7' r=1.031'		
s=.0385 '/' n=.05 V=5.95 fps L=1274' Capacity=59.5 cfs		
Total Length= 4220 ft		Total Tc= 56.9

SUBCATCHMENT 3 RUNOFF PEAK= 59.66 CFS @ 8.55 HOURS

HOUR	0.00	.05	.10	.15	.20	.25	.30	.35	.40	.45
5.00	3.50	3.67	3.85	4.02	4.21	4.40	4.59	4.79	4.99	5.20
5.50	5.42	5.63	5.86	6.09	6.32	6.55	6.78	7.03	7.26	7.50
6.00	7.74	7.97	8.23	8.47	8.73	9.00	9.27	9.56	9.86	10.18
6.50	10.51	10.84	11.19	11.53	11.87	12.22	12.54	12.87	13.17	13.46
7.00	13.75	14.00	14.28	14.55	14.82	15.13	15.44	15.80	16.18	16.60
7.50	17.08	17.60	18.25	19.03	19.98	21.19	22.66	24.51	26.72	29.32
8.00	32.29	35.57	39.04	42.55	46.03	49.36	52.31	54.90	57.00	58.45
8.50	59.43	59.66	59.46	58.85	57.73	56.45	54.88	53.22	51.54	49.78
9.00	48.16	46.58	45.09	43.72	42.38	41.18	40.00	38.86	37.82	36.76
9.50	35.79	34.82	33.87	33.01	32.12	31.34	30.57	29.84	29.20	28.56
10.00	28.01	27.50	27.00	26.58	26.14	25.76	25.41	25.04	24.74	24.40
10.50	24.10	23.81	23.50	23.25	22.97	22.72	22.49	22.25	22.07	21.87
11.00	21.70	21.55	21.38	21.26	21.12	20.99	20.88	20.73	20.63	20.49
11.50	20.35	20.24	20.08	19.95	19.80	19.65	19.51	19.34	19.20	19.04
12.00	18.87	18.73	18.55	18.41	18.26	18.11	17.99	17.86	17.75	17.65
12.50	17.55	17.49	17.42	17.37	17.34	17.29	17.28	17.24	17.21	17.19
13.00	17.14	17.11	17.05	17.00	16.96	16.90	16.87	16.82	16.78	16.76
13.50	16.71	16.70	16.67	16.64	16.63	16.58	16.56	16.51	16.46	16.43
14.00	16.36	16.32	16.26	16.19	16.15	16.08	16.04	15.99	15.94	15.91
14.50	15.86	15.84	15.81	15.77	15.76	15.72	15.70	15.69	15.65	15.64

TYPE IA 24-HOUR RAINFALL= 5.00 IN

Prepared by Civil West Engineering Services, Inc.

24 Sept 08

HydroCAD 5.11 001354 (c) 1986-1999 Applied Microcomputer Systems

SUBCATCHMENT 4 BASIN D1 - BUILDOUT

PEAK= 69.13 CFS @ 8.39 HRS, VOLUME= 19.34 AF

ACRES	CN		SCS TR-20 METHOD
50.00	87	1/4 ACRE RES. - GROUP D SOIL	TYPE IA 24-HOUR
11.10	82	2 ACRE RES. - GROUP D SOIL	RAINFALL= 5.00 IN
25.70	79	FOREST - GROUP D SOIL	SPAN= 5-15 HRS, dt=.05 HRS
3.40	92	MULTI-FAMILY RES. - GROUP D SOIL	
2.10	80	URBAN, GOOD COND. - GROUP D SOIL	
19.70	72	FOREST - GROUP C SOIL	
6.10	79	DEVELOPMENT CONSTRAINED - GRP. D	
118.10	82		

Method	Comment	Tc (min)
TR-55 SHEET FLOW	SHEET FLOW	15.7
Woods: Light underbrush	n=.4 L=300' P2=3.5 in s=.35 '/'	
SHALLOW CONCENTRATED/UPLAND FLOW	SHALLOW CONCENTRATED - SEGMENT 1	6.4
Woodland Kv=5 L=1372' s=.5138 '/' V=3.58 fps		
SHALLOW CONCENTRATED/UPLAND FLOW	SHALLOW CONCENTRATED - SEGMENT 2	19.7
Woodland Kv=5 L=2544' s=.1847 '/' V=2.15 fps		
CHANNEL FLOW	NATURAL CHANNEL	1.5
a=7.5 sq-ft Pw=7.2' r=1.042'		
s=.0839 '/' n=.04 V=11.06 fps L=977' Capacity=82.9 cfs		
CIRCULAR CHANNEL	CULVERT	1.2
30" Diameter a=4.91 sq-ft Pw=7.9' r=.625'		
s=.0347 '/' n=.011 V=18.4 fps L=1324' Capacity=90.3 cfs		
Total Length= 6517 ft		Total Tc= 44.5

SUBCATCHMENT 4 RUNOFF PEAK= 69.13 CFS @ 8.39 HOURS

HOUR	0.00	.05	.10	.15	.20	.25	.30	.35	.40	.45
5.00	3.81	4.01	4.20	4.41	4.61	4.83	5.05	5.28	5.52	5.76
5.50	6.00	6.26	6.51	6.77	7.02	7.28	7.54	7.80	8.04	8.31
6.00	8.56	8.83	9.09	9.38	9.67	10.00	10.32	10.68	11.05	11.44
6.50	11.83	12.24	12.63	13.03	13.39	13.75	14.07	14.37	14.63	14.90
7.00	15.14	15.41	15.67	15.98	16.30	16.68	17.10	17.59	18.12	18.74
7.50	19.41	20.20	21.12	22.33	23.88	25.92	28.51	31.77	35.64	40.00
8.00	44.67	49.47	54.18	58.57	62.38	65.53	67.73	68.94	69.10	68.47
8.50	67.11	65.26	62.99	60.54	57.97	55.43	53.02	50.84	48.90	47.13
9.00	45.53	44.07	42.72	41.45	40.27	39.14	38.06	36.99	35.96	34.95
9.50	34.01	33.09	32.24	31.42	30.68	29.97	29.36	28.78	28.28	27.81
10.00	27.41	27.02	26.69	26.34	26.05	25.74	25.46	25.16	24.89	24.60
10.50	24.35	24.07	23.85	23.60	23.41	23.20	23.05	22.88	22.77	22.63
11.00	22.53	22.41	22.32	22.19	22.10	21.97	21.86	21.71	21.59	21.44
11.50	21.31	21.14	21.01	20.83	20.69	20.51	20.35	20.16	20.00	19.81
12.00	19.65	19.46	19.31	19.15	19.02	18.88	18.78	18.67	18.60	18.53
12.50	18.50	18.46	18.45	18.44	18.44	18.44	18.44	18.41	18.39	18.34
13.00	18.29	18.22	18.16	18.09	18.04	17.99	17.95	17.93	17.91	17.91



TYPE IA 24-HOUR RAINFALL= 6.00 IN

Prepared by HBH Consulting Engineers, Inc.

14 Oct 08

HydroCAD 5.11 001354 (c) 1986-1999 Applied Microcomputer Systems

SUBCATCHMENT 4 BASIN D1 - BUILDOUT

PEAK= 91.59 CFS @ 8.38 HRS, VOLUME= 25.41 AF

ACRES	CN		SCS TR-20 METHOD
50.00	87	1/4 ACRE RES. - GROUP D SOIL	TYPE IA 24-HOUR
11.10	82	2 ACRE RES. - GROUP D SOIL	RAINFALL= 6.00 IN
25.70	79	FOREST - GROUP D SOIL	SPAN= 5-15 HRS, dt=.05 HRS
3.40	92	MULTI-FAMILY RES. - GROUP D SOIL	
2.10	80	URBAN, GOOD COND. - GROUP D SOIL	
19.70	72	FOREST - GROUP C SOIL	
6.10	79	DEVELOPMENT CONSTRAINED - GRP. D	
118.10	82		

Method	Comment	Tc (min)
TR-55 SHEET FLOW	SHEET FLOW	15.7
Woods: Light underbrush	n=.4 L=300' P2=3.5 in s=.35 '/'	
SHALLOW CONCENTRATED/UPLAND FLOW	SHALLOW CONCENTRATED - SEGMENT 1	6.4
Woodland	Kv=5 L=1372' s=.5138 '/' V=3.58 fps	
SHALLOW CONCENTRATED/UPLAND FLOW	SHALLOW CONCENTRATED - SEGMENT 2	19.7
Woodland	Kv=5 L=2544' s=.1847 '/' V=2.15 fps	
CHANNEL FLOW	NATURAL CHANNEL	1.5
a=7.5 sq-ft Pw=7.2' r=1.042'		
s=.0839 '/' n=.04 V=11.06 fps	L=977' Capacity=82.9 cfs	
CIRCULAR CHANNEL	CULVERT	1.2
30" Diameter a=4.91 sq-ft Pw=7.9' r=.625'		
s=.0347 '/' n=.011 V=18.4 fps	L=1324' Capacity=90.3 cfs	

Total Length= 6517 ft Total Tc= 44.5

SUBCATCHMENT 4 RUNOFF PEAK= 91.59 CFS @ 8.38 HOURS

HOUR	0.00	.05	.10	.15	.20	.25	.30	.35	.40	.45
5.00	6.87	7.13	7.39	7.67	7.94	8.24	8.53	8.84	9.15	9.48
5.50	9.81	10.15	10.48	10.83	11.16	11.51	11.84	12.18	12.50	12.84
6.00	13.16	13.51	13.85	14.23	14.61	15.03	15.45	15.93	16.41	16.93
6.50	17.44	17.98	18.48	19.00	19.47	19.93	20.32	20.71	21.02	21.35
7.00	21.63	21.95	22.27	22.65	23.04	23.53	24.05	24.68	25.37	26.17
7.50	27.04	28.07	29.26	30.86	32.91	35.60	39.03	43.35	48.46	54.21
8.00	60.34	66.61	72.74	78.42	83.31	87.30	90.03	91.45	91.48	90.49
8.50	88.53	85.95	82.82	79.48	76.00	72.57	69.31	66.38	63.75	61.37
9.00	59.22	57.24	55.44	53.73	52.15	50.63	49.19	47.75	46.40	45.06
9.50	43.81	42.58	41.46	40.38	39.40	38.47	37.66	36.89	36.24	35.61
10.00	35.09	34.56	34.12	33.66	33.28	32.86	32.50	32.09	31.74	31.35
10.50	31.03	30.66	30.37	30.04	29.79	29.51	29.31	29.08	28.93	28.74
11.00	28.62	28.45	28.33	28.16	28.03	27.86	27.71	27.52	27.36	27.16
11.50	26.99	26.77	26.59	26.37	26.18	25.94	25.74	25.49	25.28	25.03
12.00	24.83	24.59	24.39	24.18	24.01	23.83	23.70	23.56	23.47	23.37
12.50	23.32	23.27	23.26	23.24	23.24	23.23	23.22	23.19	23.15	23.09
13.00	23.02	22.93	22.85	22.76	22.69	22.62	22.57	22.54	22.52	22.51

TYPE IA 24-HOUR RAINFALL= 6.00 IN

Prepared by HBH Consulting Engineers, Inc.

14 Oct 08

HydroCAD 5.11 001354 (c) 1986-1999 Applied Microcomputer Systems

SUBCATCHMENT 3 BASIN C - 20 YEAR

PEAK= 78.48 CFS @ 8.54 HRS, VOLUME= 23.64 AF

ACRES	CN		SCS TR-20 METHOD
16.90	85	1/2 ACRE RES. - GROUP D SOIL	TYPE IA 24-HOUR
6.00	82	2 ACRE RES. - GROUP D SOIL	RAINFALL= 6.00 IN
36.00	87	1/4 ACRE RES. - GROUP D SOIL	SPAN= 5-15 HRS, dt=.05 HRS
2.00	79	UNDEVELOPED RES. - GROUP D SOIL	
2.30	93	PUBLIC (INDUSTRIAL) - GROUP D	
25.50	79	FOREST - GROUP D SOIL	
18.90	79	DEVELOPMENT CONSTRAINED - GRP. D	
107.60	83		

Method	Comment	Tc (min)
TR-55 SHEET FLOW	OVERLAND SHEET FLOW	40.3
Woods: Light underbrush n=.4 L=300' P2=3.5 in s=.0333 '/'		
SHALLOW CONCENTRATED/UPLAND FLOW	SHALLOW CONCENTRATED FLOW	11.2
Woodland Kv=5 L=1570' s=.2197 '/' V=2.34 fps		
CHANNEL FLOW	CHANNEL FLOW SEGMENT 1	1.8
a=3 sq-ft Pw=4.8' r=.625'		
s=.1366 '/' n=.04 V=10.04 fps L=1076' Capacity=30.1 cfs		
CHANNEL FLOW	CHANNEL FLOW SEGMENT 2	3.6
a=10 sq-ft Pw=9.7' r=1.031'		
s=.0385 '/' n=.05 V=5.95 fps L=1274' Capacity=59.5 cfs		
Total Length= 4220 ft		Total Tc= 56.9

SUBCATCHMENT 3 RUNOFF PEAK= 78.48 CFS @ 8.54 HOURS

HOUR	0.00	.05	.10	.15	.20	.25	.30	.35	.40	.45
5.00	6.22	6.44	6.68	6.91	7.16	7.41	7.67	7.94	8.20	8.49
5.50	8.77	9.06	9.36	9.66	9.97	10.28	10.58	10.90	11.20	11.51
6.00	11.82	12.13	12.45	12.77	13.10	13.45	13.79	14.18	14.56	14.97
6.50	15.40	15.83	16.29	16.73	17.18	17.62	18.03	18.45	18.83	19.19
7.00	19.55	19.86	20.21	20.53	20.87	21.25	21.63	22.08	22.56	23.08
7.50	23.70	24.36	25.20	26.22	27.45	29.03	30.95	33.37	36.27	39.66
8.00	43.55	47.83	52.33	56.89	61.37	65.67	69.43	72.71	75.35	77.13
8.50	78.29	78.47	78.08	77.17	75.59	73.81	71.66	69.41	67.13	64.77
9.00	62.58	60.45	58.45	56.61	54.83	53.21	51.63	50.12	48.73	47.32
9.50	46.04	44.75	43.49	42.36	41.19	40.15	39.15	38.18	37.34	36.50
10.00	35.78	35.10	34.43	33.88	33.31	32.81	32.34	31.86	31.46	31.01
10.50	30.62	30.24	29.83	29.50	29.13	28.80	28.51	28.19	27.95	27.69
11.00	27.46	27.27	27.05	26.89	26.70	26.53	26.38	26.19	26.04	25.87
11.50	25.69	25.53	25.33	25.16	24.97	24.77	24.59	24.37	24.18	23.98
12.00	23.76	23.58	23.35	23.17	22.98	22.78	22.63	22.45	22.31	22.19
12.50	22.05	21.98	21.88	21.82	21.77	21.70	21.69	21.63	21.60	21.56
13.00	21.49	21.46	21.38	21.32	21.27	21.18	21.14	21.07	21.02	20.99
13.50	20.93	20.91	20.87	20.83	20.81	20.75	20.72	20.66	20.59	20.55
14.00	20.46	20.40	20.33	20.24	20.18	20.09	20.04	19.98	19.91	19.87

14.50 | 19.81 19.78 19.74 19.69 19.67 19.62 19.60 19.57 19.52 19.51
15.00 | 19.47

TYPE IA 24-HOUR RAINFALL= 6.00 IN

Prepared by HBH Consulting Engineers, Inc.

14 Oct 08

HydroCAD 5.11 001354 (c) 1986-1999 Applied Microcomputer Systems

SUBCATCHMENT 4 BASIN D1 - 20 YEAR

PEAK= 91.59 CFS @ 8.38 HRS, VOLUME= 25.41 AF

ACRES	CN		SCS TR-20 METHOD
50.00	87	1/4 ACRE RES. - GROUP D SOIL	TYPE IA 24-HOUR
11.10	82	2 ACRE RES. - GROUP D SOIL	RAINFALL= 6.00 IN
25.70	79	FOREST - GROUP D SOIL	SPAN= 5-15 HRS, dt=.05 HRS
3.40	92	MULTI-FAMILY RES. - GROUP D SOIL	
2.10	80	URBAN, GOOD COND. - GROUP D SOIL	
19.70	72	FOREST - GROUP C SOIL	
6.10	79	DEVELOPMENT CONSTRAINED - GRP. D	
118.10	82		

Method	Comment	Tc (min)
TR-55 SHEET FLOW	SHEET FLOW	15.7
Woods: Light underbrush n=.4 L=300' P2=3.5 in s=.35 '/'		
SHALLOW CONCENTRATED/UPLAND FLOW	SHALLOW CONCENTRATED - SEGMENT 1	6.4
Woodland Kv=5 L=1372' s=.5138 '/' V=3.58 fps		
SHALLOW CONCENTRATED/UPLAND FLOW	SHALLOW CONCENTRATED - SEGMENT 2	19.7
Woodland Kv=5 L=2544' s=.1847 '/' V=2.15 fps		
CHANNEL FLOW	NATURAL CHANNEL	1.5
a=7.5 sq-ft Pw=7.2' r=1.042'		
s=.0839 '/' n=.04 V=11.06 fps L=977' Capacity=82.9 cfs		
CIRCULAR CHANNEL	CULVERT	1.2
30" Diameter a=4.91 sq-ft Pw=7.9' r=.625'		
s=.0347 '/' n=.011 V=18.4 fps L=1324' Capacity=90.3 cfs		
Total Length= 6517 ft		Total Tc= 44.5

SUBCATCHMENT 4 RUNOFF PEAK= 91.59 CFS @ 8.38 HOURS

HOUR	0.00	.05	.10	.15	.20	.25	.30	.35	.40	.45
5.00	6.87	7.13	7.39	7.67	7.94	8.24	8.53	8.84	9.15	9.48
5.50	9.81	10.15	10.48	10.83	11.16	11.51	11.84	12.18	12.50	12.84
6.00	13.16	13.51	13.85	14.23	14.61	15.03	15.45	15.93	16.41	16.93
6.50	17.44	17.98	18.48	19.00	19.47	19.93	20.32	20.71	21.02	21.35
7.00	21.63	21.95	22.27	22.65	23.04	23.53	24.05	24.68	25.37	26.17
7.50	27.04	28.07	29.26	30.86	32.91	35.60	39.03	43.35	48.46	54.21
8.00	60.34	66.61	72.74	78.42	83.31	87.30	90.03	91.45	91.48	90.49
8.50	88.53	85.95	82.82	79.48	76.00	72.57	69.31	66.38	63.75	61.37
9.00	59.22	57.24	55.44	53.73	52.15	50.63	49.19	47.75	46.40	45.06
9.50	43.81	42.58	41.46	40.38	39.40	38.47	37.66	36.89	36.24	35.61
10.00	35.09	34.56	34.12	33.66	33.28	32.86	32.50	32.09	31.74	31.35
10.50	31.03	30.66	30.37	30.04	29.79	29.51	29.31	29.08	28.93	28.74
11.00	28.62	28.45	28.33	28.16	28.03	27.86	27.71	27.52	27.36	27.16
11.50	26.99	26.77	26.59	26.37	26.18	25.94	25.74	25.49	25.28	25.03
12.00	24.83	24.59	24.39	24.18	24.01	23.83	23.70	23.56	23.47	23.37
12.50	23.32	23.27	23.26	23.24	23.24	23.23	23.22	23.19	23.15	23.09
13.00	23.02	22.93	22.85	22.76	22.69	22.62	22.57	22.54	22.52	22.51

TYPE IA 24-HOUR RAINFALL= 6.00 IN

Prepared by HBH Consulting Engineers, Inc.

14 Oct 08

HydroCAD 5.11 001354 (c) 1986-1999 Applied Microcomputer Systems

SUBCATCHMENT 3 BASIN C - EXISTING

PEAK= 70.92 CFS @ 8.55 HRS, VOLUME= 21.50 AF

ACRES	CN		SCS TR-20 METHOD
16.90	85	1/2 ACRE RES. - GROUP D SOIL	TYPE IA 24-HOUR
6.00	82	2 ACRE RES. - GROUP D SOIL	RAINFALL= 6.00 IN
25.50	79	FOREST LAND - GROUP D SOIL	SPAN= 5-15 HRS, dt=.05 HRS
2.30	93	PUBLIC (INDUSTRIAL) - GROUP D	
18.90	79	DEVELOPMENT CONSTRAINED - GRP. D	
38.00	79	UNDEVELOPED RES. - GROUP D SOIL	
107.60	80		

Method	Comment	Tc (min)
TR-55 SHEET FLOW	OVERLAND SHEET FLOW	40.3
Woods: Light underbrush	n=.4 L=300' P2=3.5 in s=.0333 '/'	
SHALLOW CONCENTRATED/UPLAND FLOW	SHALLOW CONCENTRATED FLOW	11.2
Woodland	Kv=5 L=1570' s=.2197 '/' V=2.34 fps	
CHANNEL FLOW	CHANNEL FLOW SEGMENT 1	1.8
a=3 sq-ft Pw=4.8' r=.625'		
s=.1366 '/' n=.04 V=10.04 fps	L=1076' Capacity=30.1 cfs	
CHANNEL FLOW	CHANNEL FLOW SEGMENT 2	3.6
a=10 sq-ft Pw=9.7' r=1.031'		
s=.0385 '/' n=.05 V=5.95 fps	L=1274' Capacity=59.5 cfs	
Total Length= 4220 ft		Total Tc= 56.9

SUBCATCHMENT 3 RUNOFF PEAK= 70.92 CFS @ 8.55 HOURS

HOUR	0.00	.05	.10	.15	.20	.25	.30	.35	.40	.45
5.00	4.02	4.22	4.43	4.64	4.86	5.08	5.31	5.55	5.78	6.04
5.50	6.29	6.55	6.82	7.09	7.36	7.64	7.91	8.20	8.48	8.76
6.00	9.05	9.33	9.63	9.92	10.23	10.55	10.87	11.22	11.57	11.95
6.50	12.34	12.74	13.15	13.56	13.97	14.38	14.77	15.16	15.52	15.86
7.00	16.21	16.51	16.85	17.17	17.49	17.86	18.23	18.66	19.11	19.61
7.50	20.19	20.80	21.58	22.51	23.64	25.08	26.83	29.03	31.66	34.74
8.00	38.28	42.19	46.30	50.49	54.63	58.60	62.11	65.20	67.71	69.45
8.50	70.62	70.91	70.68	69.97	68.64	67.13	65.28	63.31	61.32	59.24
9.00	57.31	55.44	53.67	52.05	50.46	49.03	47.63	46.29	45.05	43.78
9.50	42.64	41.49	40.36	39.34	38.28	37.35	36.44	35.56	34.81	34.05
10.00	33.40	32.78	32.19	31.69	31.17	30.72	30.30	29.86	29.50	29.10
10.50	28.75	28.40	28.04	27.73	27.40	27.10	26.83	26.55	26.33	26.09
11.00	25.89	25.72	25.52	25.38	25.21	25.05	24.92	24.75	24.62	24.46
11.50	24.29	24.16	23.97	23.82	23.64	23.46	23.30	23.09	22.92	22.73
12.00	22.53	22.36	22.15	21.98	21.81	21.62	21.49	21.32	21.20	21.08
12.50	20.96	20.89	20.80	20.74	20.70	20.65	20.63	20.59	20.56	20.53
13.00	20.47	20.44	20.37	20.31	20.26	20.19	20.15	20.09	20.04	20.02
13.50	19.96	19.95	19.91	19.88	19.86	19.81	19.78	19.73	19.67	19.63
14.00	19.55	19.49	19.42	19.34	19.29	19.21	19.16	19.11	19.04	19.01
14.50	18.95	18.92	18.89	18.85	18.83	18.79	18.77	18.74	18.70	18.69

15.00 | 18.65

Data for LOWELL BASINS A - D, EXISTING

Page 4

TYPE IA 24-HOUR RAINFALL= 6.00 IN

Prepared by HBH Consulting Engineers, Inc.

14 Oct 08

HydroCAD 5.11 001354 (c) 1986-1999 Applied Microcomputer Systems

SUBCATCHMENT 4

BASIN D1 - EXISTING

PEAK= 82.50 CFS @ 8.39 HRS, VOLUME= 23.09 AF

ACRES	CN		SCS TR-20 METHOD
17.00	87	1/4 ACRE RES. - GROUP D SOIL	TYPE IA 24-HOUR
11.10	82	2 ACRE RES. - GROUP D SOIL	RAINFALL= 6.00 IN
25.70	79	FOREST - GROUP D SOIL	SPAN= 5-15 HRS, dt=.05 HRS
3.40	84	URBAN, FAIR COND. - GROUP D SOIL	
33.00	79	RES. UNDEVELOPED - GROUP D SOIL	
2.10	80	URBAN, GOOD COND. - GROUP D SOIL	
19.70	72	FOREST - GROUP C SOIL	
6.10	79	RES. CONSTRAINED - GROUP D SOIL	
118.10	79		

Method	Comment	Tc (min)
TR-55 SHEET FLOW	SHEET FLOW	15.7
Woods: Light underbrush n=.4 L=300' P2=3.5 in s=.35 '/'		
SHALLOW CONCENTRATED/UPLAND FLOW	SHALLOW CONCENTRATED - SEGMENT 1	6.4
Woodland Kv=5 L=1372' s=.5138 '/' V=3.58 fps		
SHALLOW CONCENTRATED/UPLAND FLOW	SHALLOW CONCENTRATED - SEGMENT 2	19.7
Woodland Kv=5 L=2544' s=.1847 '/' V=2.15 fps		
CHANNEL FLOW	NATURAL CHANNEL	1.5
a=7.5 sq-ft Pw=7.2' r=1.042'		
s=.0839 '/' n=.04 V=11.06 fps L=977' Capacity=82.9 cfs		
CIRCULAR CHANNEL	CULVERT	1.2
30" Diameter a=4.91 sq-ft Pw=7.9' r=.625'		
s=.0347 '/' n=.011 V=18.4 fps L=1324' Capacity=90.3 cfs		
Total Length= 6517 ft		Total Tc= 44.5



Stormwater Master Plan

Appendix B



Table 2-2a Runoff curve numbers for urban areas ^{1/}

Cover description	Average percent impervious area ^{2/}	Curve numbers for hydrologic soil group			
		A	B	C	D
<i>Fully developed urban areas (vegetation established)</i>					
Open space (lawns, parks, golf courses, cemeteries, etc.) ^{3/} :					
Poor condition (grass cover < 50%)		68	79	86	89
Fair condition (grass cover 50% to 75%)		49	69	79	84
Good condition (grass cover > 75%)		39	61	74	80
Impervious areas:					
Paved parking lots, roofs, driveways, etc. (excluding right-of-way)		98	98	98	98
Streets and roads:					
Paved; curbs and storm sewers (excluding right-of-way)		98	98	98	98
Paved; open ditches (including right-of-way)		83	89	92	93
Gravel (including right-of-way)		76	85	89	91
Dirt (including right-of-way)		72	82	87	89
Western desert urban areas:					
Natural desert landscaping (pervious areas only) ^{4/}		63	77	85	88
Artificial desert landscaping (impervious weed barrier, desert shrub with 1- to 2-inch sand or gravel mulch and basin borders)		96	96	96	96
Urban districts:					
Commercial and business	85	89	92	94	95
Industrial	72	81	88	91	93
Residential districts by average lot size:					
1/8 acre or less (town houses)	65	77	85	90	92
1/4 acre	38	61	75	83	87
1/3 acre	30	57	72	81	86
1/2 acre	25	54	70	80	85
1 acre	20	51	68	79	84
2 acres	12	46	65	77	82
<i>Developing urban areas</i>					
Newly graded areas (pervious areas only, no vegetation) ^{5/}					
		77	86	91	94
Idle lands (CN's are determined using cover types similar to those in table 2-2c).					

^{1/} Average runoff condition, and $I_a = 0.2S$.

^{2/} The average percent impervious area shown was used to develop the composite CN's. Other assumptions are as follows: impervious areas are directly connected to the drainage system, impervious areas have a CN of 98, and pervious areas are considered equivalent to open space in good hydrologic condition. CN's for other combinations of conditions may be computed using figure 2-3 or 2-4.

^{3/} CN's shown are equivalent to those of pasture. Composite CN's may be computed for other combinations of open space cover type.

^{4/} Composite CN's for natural desert landscaping should be computed using figures 2-3 or 2-4 based on the impervious area percentage (CN = 98) and the pervious area CN. The pervious area CN's are assumed equivalent to desert shrub in poor hydrologic condition.

^{5/} Composite CN's to use for the design of temporary measures during grading and construction should be computed using figure 2-3 or 2-4 based on the degree of development (impervious area percentage) and the CN's for the newly graded pervious areas.

Table 2-2b Runoff curve numbers for cultivated agricultural lands ^{1/}

Cover description		Hydrologic condition ^{3/}	Curve numbers for hydrologic soil group			
Cover type	Treatment ^{2/}		A	B	C	D
Fallow	Bare soil	—	77	86	91	94
	Crop residue cover (CR)	Poor	76	85	90	93
		Good	74	83	88	90
Row crops	Straight row (SR)	Poor	72	81	88	91
		Good	67	78	85	89
	SR + CR	Poor	71	80	87	90
		Good	64	75	82	85
	Contoured (C)	Poor	70	79	84	88
		Good	65	75	82	86
	C + CR	Poor	69	78	83	87
		Good	64	74	81	85
	Contoured & terraced (C&T)	Poor	66	74	80	82
		Good	62	71	78	81
C&T+ CR	Poor	65	73	79	81	
	Good	61	70	77	80	
Small grain	SR	Poor	65	76	84	88
		Good	63	75	83	87
	SR + CR	Poor	64	75	83	86
		Good	60	72	80	84
	C	Poor	63	74	82	85
		Good	61	73	81	84
	C + CR	Poor	62	73	81	84
		Good	60	72	80	83
	C&T	Poor	61	72	79	82
		Good	59	70	78	81
C&T+ CR	Poor	60	71	78	81	
	Good	58	69	77	80	
Close-seeded or broadcast legumes or rotation meadow	SR	Poor	66	77	85	89
		Good	58	72	81	85
	C	Poor	64	75	83	85
		Good	55	69	78	83
	C&T	Poor	63	73	80	83
Good	51	67	76	80		

¹ Average runoff condition, and $I_a=0.2S$

² Crop residue cover applies only if residue is on at least 5% of the surface throughout the year.

³ Hydraulic condition is based on combination factors that affect infiltration and runoff, including (a) density and canopy of vegetative areas, (b) amount of year-round cover, (c) amount of grass or close-seeded legumes, (d) percent of residue cover on the land surface (good $\geq 20\%$), and (e) degree of surface roughness.

Poor: Factors impair infiltration and tend to increase runoff.

Good: Factors encourage average and better than average infiltration and tend to decrease runoff.

Table 2-2c Runoff curve numbers for other agricultural lands ^{1/}

Cover type	Cover description	Hydrologic condition	Curve numbers for hydrologic soil group			
			A	B	C	D
Pasture, grassland, or range—continuous forage for grazing. ^{2/}		Poor	68	79	86	89
		Fair	49	69	79	84
		Good	39	61	74	80
Meadow—continuous grass, protected from grazing and generally mowed for hay.		—	30	58	71	78
Brush—brush-weed-grass mixture with brush the major element. ^{3/}		Poor	48	67	77	83
		Fair	35	56	70	77
		Good	30 ^{4/}	48	65	73
Woods—grass combination (orchard or tree farm). ^{5/}		Poor	57	73	82	86
		Fair	43	65	76	82
		Good	32	58	72	79
Woods. ^{6/}		Poor	45	66	77	83
		Fair	36	60	73	79
		Good	30 ^{4/}	55	70	77
Farmsteads—buildings, lanes, driveways, and surrounding lots.		—	59	74	82	86

^{1/} Average runoff condition, and $I_a = 0.2S$.^{2/} *Poor*: <50% ground cover or heavily grazed with no mulch.*Fair*: 50 to 75% ground cover and not heavily grazed.*Good*: >75% ground cover and lightly or only occasionally grazed.^{3/} *Poor*: <50% ground cover.*Fair*: 50 to 75% ground cover.*Good*: >75% ground cover.^{4/} Actual curve number is less than 30; use CN = 30 for runoff computations.^{5/} CN's shown were computed for areas with 50% woods and 50% grass (pasture) cover. Other combinations of conditions may be computed from the CN's for woods and pasture.^{6/} *Poor*: Forest litter, small trees, and brush are destroyed by heavy grazing or regular burning.*Fair*: Woods are grazed but not burned, and some forest litter covers the soil.*Good*: Woods are protected from grazing, and litter and brush adequately cover the soil.

Table 2-2d Runoff curve numbers for arid and semiarid rangelands ^{1/}

Cover description		Curve numbers for hydrologic soil group			
Cover type	Hydrologic condition ^{2/}	A ^{3/}	B	C	D
Herbaceous—mixture of grass, weeds, and low-growing brush, with brush the minor element.	Poor		80	87	93
	Fair		71	81	89
	Good		62	74	85
Oak-aspen—mountain brush mixture of oak brush, aspen, mountain mahogany, bitter brush, maple, and other brush.	Poor		66	74	79
	Fair		48	57	63
	Good		30	41	48
Pinyon-juniper—pinyon, juniper, or both; grass understory.	Poor		75	85	89
	Fair		58	73	80
	Good		41	61	71
Sagebrush with grass understory.	Poor		67	80	85
	Fair		51	63	70
	Good		35	47	55
Desert shrub—major plants include saltbush, greasewood, creosotebush, blackbrush, bursage, palo verde, mesquite, and cactus.	Poor	63	77	85	88
	Fair	55	72	81	86
	Good	49	68	79	84

^{1/} Average runoff condition, and $I_a = 0.2S$. For range in humid regions, use table 2-2c.

^{2/} Poor: <30% ground cover (litter, grass, and brush overstory).

Fair: 30 to 70% ground cover.

Good: > 70% ground cover.

^{3/} Curve numbers for group A have been developed only for desert shrub.

Stormwater Master Plan

Appendix C





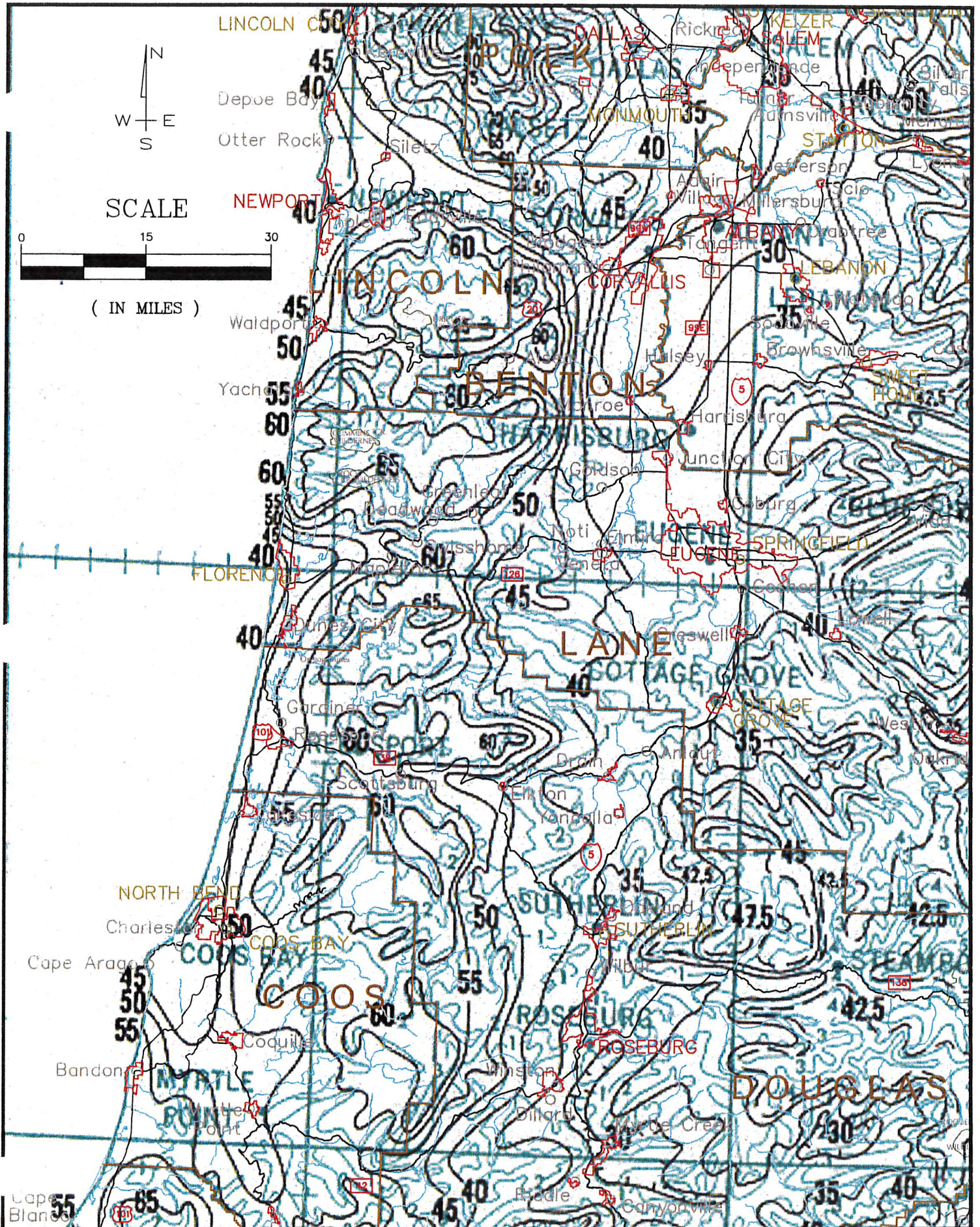



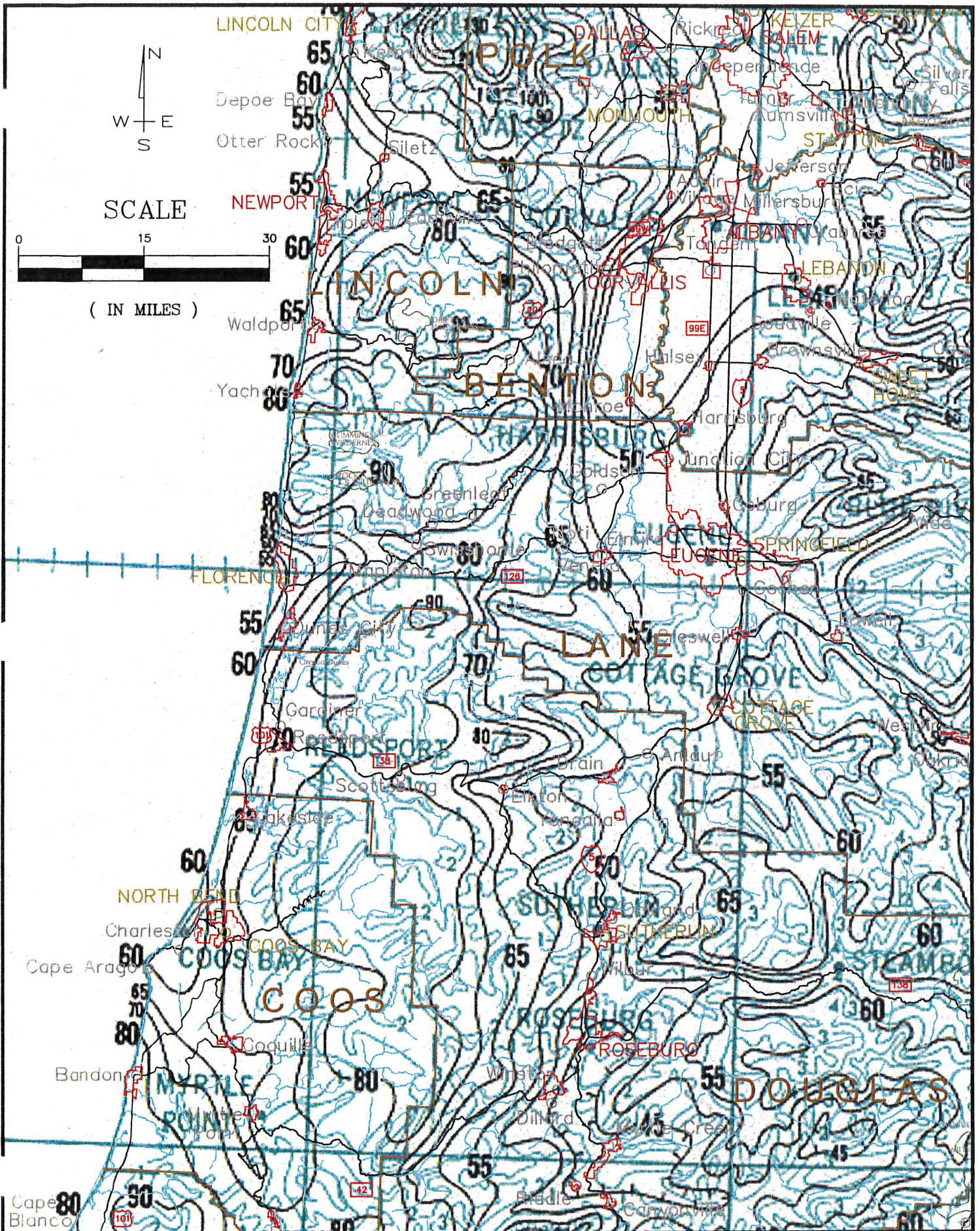

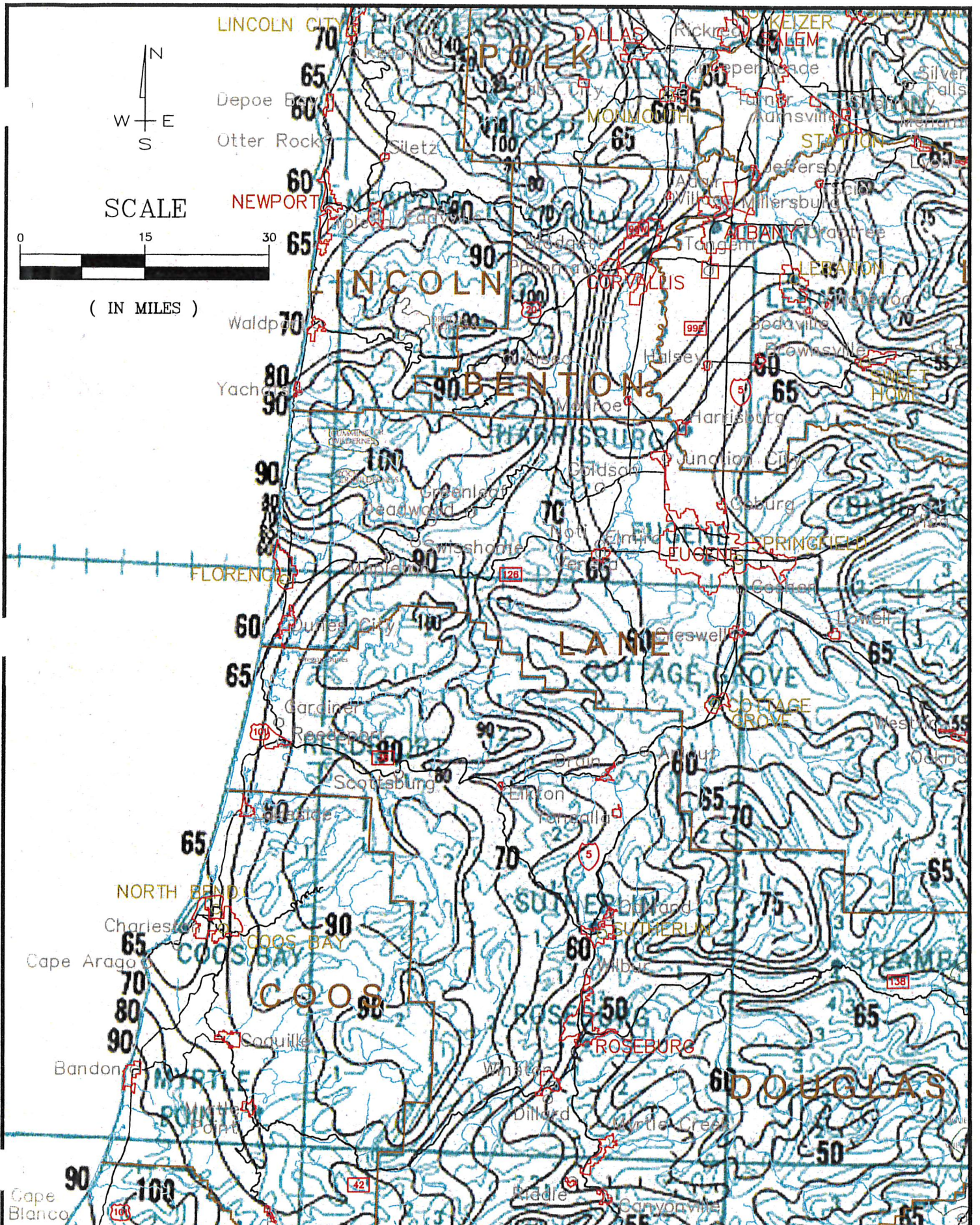



AREAS:

BASIN	AREA (ACRES)
A	234.0
B	60.4
C	107.6
D	166.2
E	150.9
F	31.8
G	64.7

NOTES:

1. CONTOURS ON THIS EXHIBIT ARE BASED ON USGS MAPS DATED 7/1/1974.
2. BASINS WERE DEVELOPED USING THE USGS MAPS ALONG WITH CONTOUR DATA PROVIDED BY LCOG.

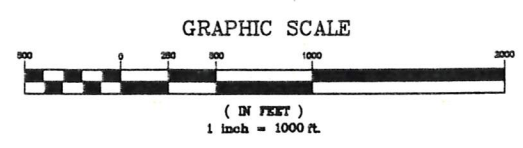

EXISTING BASINS

SCALE: 1" = 1000'